

**INSTALLER: Leave this manual with the appliance.
CONSUMER: Retain this manual for future reference.**

These instructions are supplementary to the Installation and Operating Instructions supplied with the fireplace and should be kept together. Refer to the Installation and Operating Instructions for proper gas supply, safety requirements and operating instructions

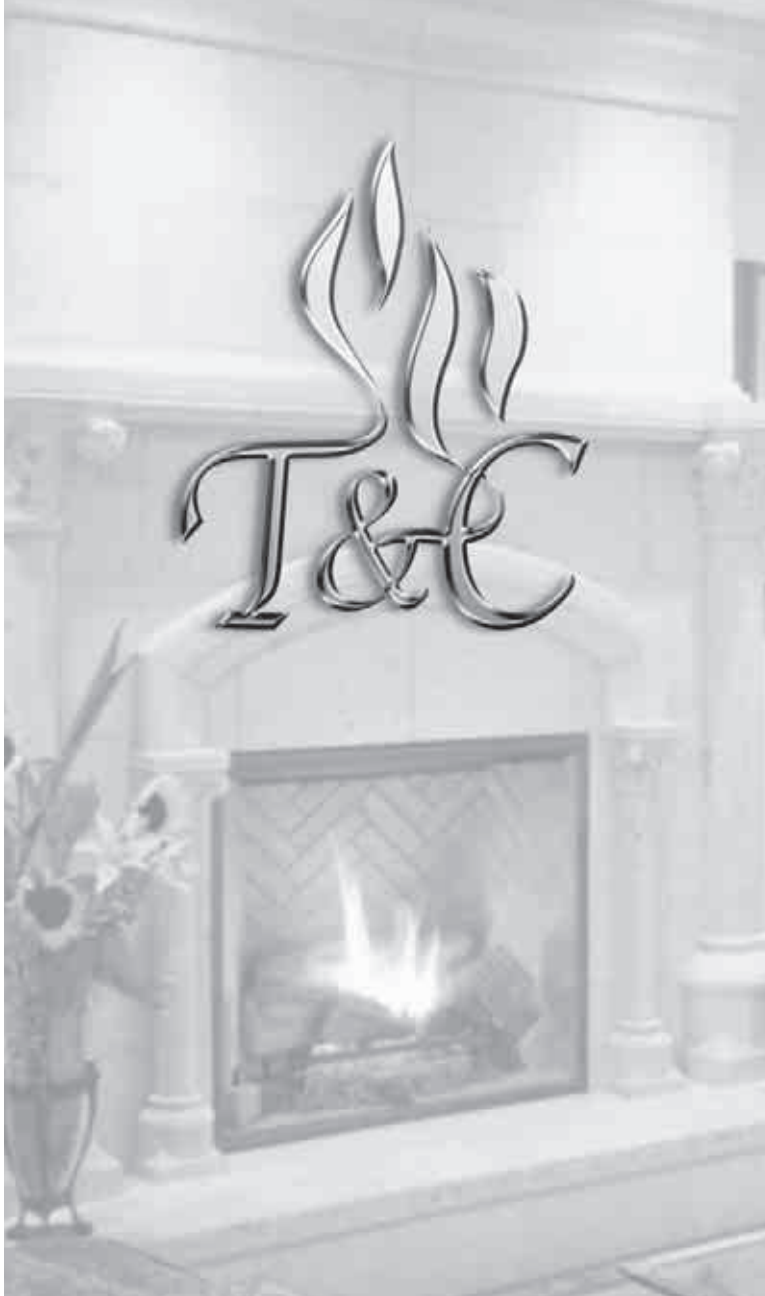

**TOWN & COUNTRY
FIREPLACES™**

TC30 COUNTRY HOME BURNER KIT INSTRUCTIONS



**PART#
TC30.NG02.C
For TC30 Series C**



Contents of Package

BURNER ASSEMBLY

7 PCS LOG SET

HARDWARE PACKAGE

EMBER MATERIAL

LOG GRATE



Burner/Grate Installation

1. Attach the burner assembly to the floor of the firebox with two screws. (Fig. # 1).



SCREWS

2. Attach the manifold supply tube to the bulk head fitting and tighten. (Fig. # 2)
Ensure that there are no leaks.

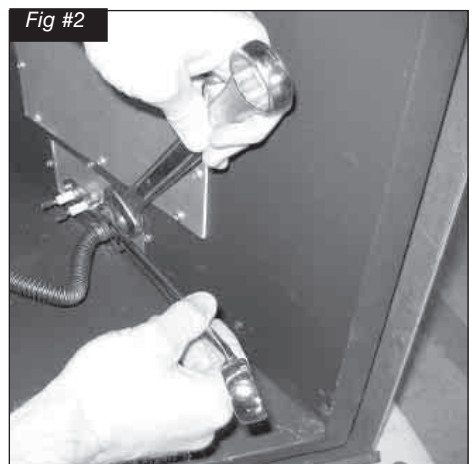
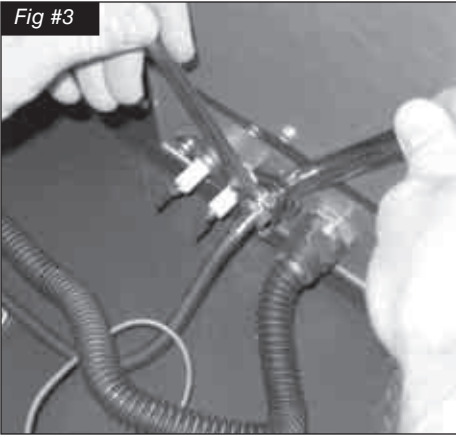
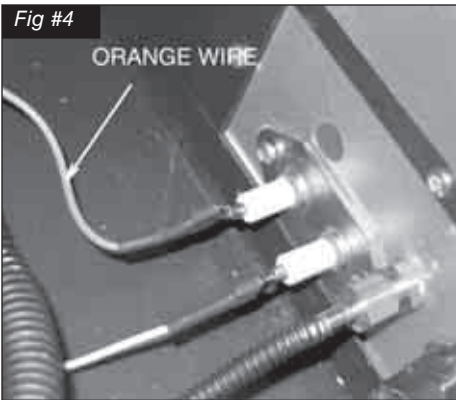

Fig #3



3. Attach the pilot supply tube to the bulk head fitting and tighten. (Fig. # 3)
Ensure there are no leaks.

Fig #4



4. Connect spark electrode wire (ORANGE) to the rear electrical bulk head fitting. Connect the flame sensor wire to the front electrical bulk head fitting. (Fig. # 4)

Fig #5



5. Position the grate over the burner tray and attach to the floor with two screws through holes located behind the front legs of the grate. (Fig. # 5)

Fig #6



6. Attach air deflector to rear of grate with two screws (Fig. # 6)

Ember Material

A large bag of ember material is shipped with the fireplace and needs to be installed to ensure optimum performance and flame appearance.

1. Pull apart the material into ember size pieces (approximately 1" squares) and gently place them into the burner pan. Do not compress, leave them loose for best performance.
2. Fill the burner pan with embers until level with the top of the pan at rear, and gradually slope forward to the firebox floor at the front, covering both burner tubes.
3. Place remaining ember material outside of the burner pan as desired to cover-up gas lines and brackets.



Note:

Ember material placement and amount will affect flame appearance. More ember material results in lower flame height. Add or remove as needed until desired flame affect is achieved. Reduce the amount used on Propane models, as too much will create soot.

Log Set Assembly

The logs are packaged in a foam pack inside the box. They are fragile and should be handled with care. Unpack and inspect log set. There should be a total of 7 logs. Gas plumbing and vent connections should be completed before proceeding.

Position the logs as indicated by the following pictures on page 5. The three main logs have holes and /or pins. Engage each pin in the corresponding holes. The four smaller logs do not have holes or pins. They rest in position. Locate as per the diagrams. (Figs. #8 – #15)



Fig #8



Fig #12

CENTER CHUNK, #4

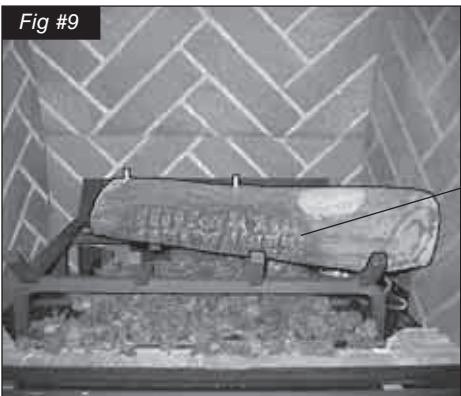

Fig #9

BASE LOG, #1



Fig #13

BOTTOM RHS CHUNK, #5



Fig #10

TOP LEFT LOG, #2



Fig #14

BOTTOM LHS CHUNK, #6



Fig #11

TOP RIGHT LOG, #3



Fig #15

BOTTOM CENTER CHUNK, #7

Propane Conversion

WARNING

This conversion kit shall be installed by a qualified service agency in accordance with the manufacturer's instructions and all applicable codes and requirements of the authority having jurisdiction.

If the information in these instructions is not followed exactly, a fire, explosion or production of carbon monoxide may result causing property damage, personal injury or loss of life.

The qualified service agency is responsible for the proper installation of this kit. The installation is not proper and complete until the operation of the converted appliance is checked as specified in the manufacturer's instructions supplied with the kit.

CAUTION

The gas supply and electrical power shall be shut off before proceeding with the conversion.

If the unit is to be used on propane convert as follows using the components supplied with this burner:

Note: Factory supplied components must be used to ensure correct input. After conversion confirm proper manifold pressure.

1. Ensure the burner, pilot and gas supply are turned off, and the appliance has cooled.
2. Remove the two screws securing the air deflector to the burner grate. (Fig. #16)
3. Remove the two screws securing the manifold assembly to the burner. (Fig. #17)

4. Remove the manifold assembly from the burner. (Fig. #18)

5. With a 1/2" wrench remove the natural gas orifice (#32) and replace with propane orifice (#48)(our part # 5021.3407) (Fig. #19)
6. Fully open the primary air shutter.
7. Reinstall the manifold and air deflector

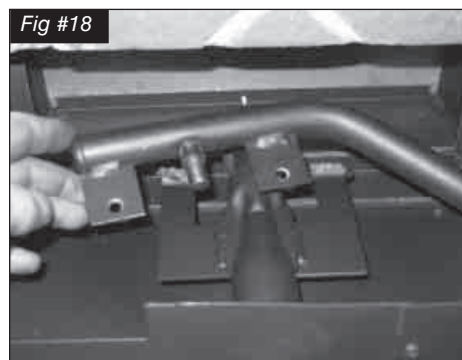
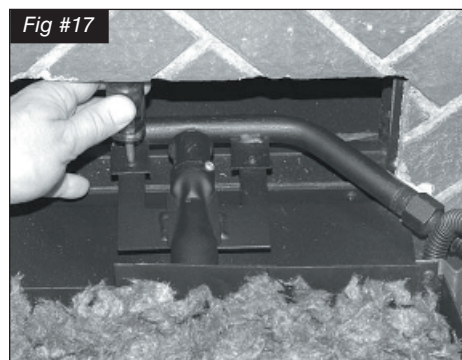
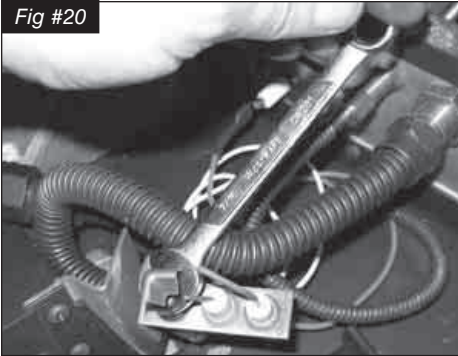
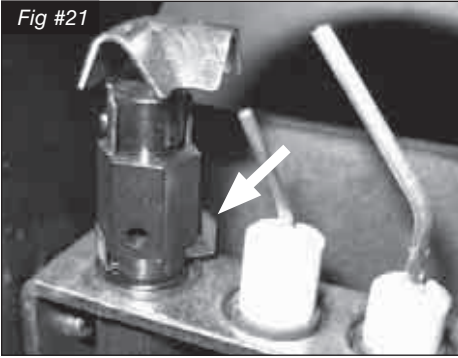

Fig #20



8. With a 7/16" wrench loosen the pilot head on the pilot assembly by a half-turn (Fig. #20)

Fig #21



9. Slide the pilot adjustment band over and ensure that the hole in the orifice band is showing. (Fig. #21 shows NG position, Fig. # 22 shows LP position)
10. Remove right hand brick panel (if installed) and control panel located on right hand side of firebox (See Fig. #27).

Fig #22

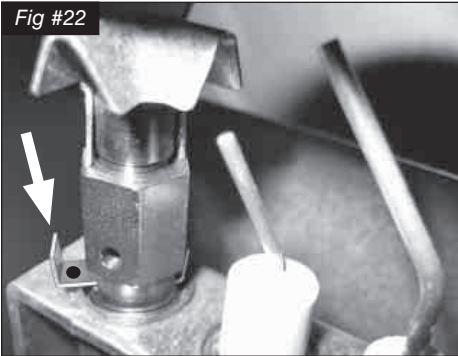
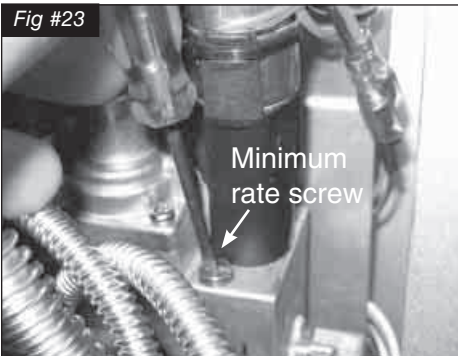

Fig #23



11. Remove the minimum rate screw located in the valve. (Fig. #23)

The minimum rate screw is sealed with an o-ring near the bottom of the screw. Use a thin bladed screwdriver to back the screw out to the limit of the threads.

A groove on the screw body will be visible just above the valve body. Insert a thin tool (knife blade or thin screwdriver blade) into the groove and gently pry the screw up.

12. Replace the minimum rate screw with the one provided in the propane conversion kit supplied with this fireplace. Ensure that the screw is fully installed. (Fig. #24)

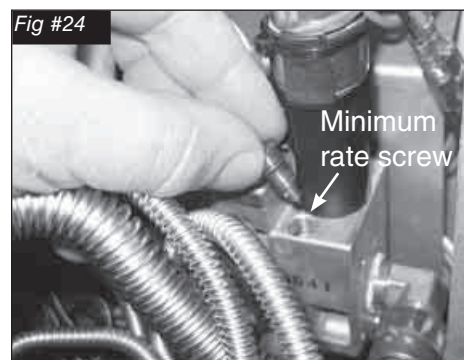

13. Pull off the rubber cap from the top of the pressure regulator. (Fig. #25)

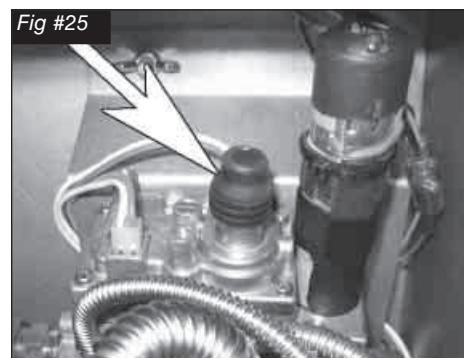

14. Press down on the center post and rotate 90°. The center post should stay down. (Fig. #26). Replace the rubber cap.

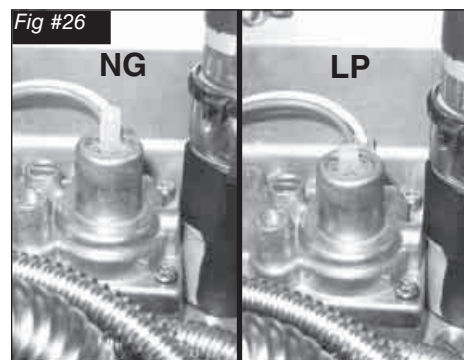

15. Fill in the date and the name of the person who performed the conversion in the white area on the conversion label. Peel off the protective backing and apply the conversion label directly over the gas specifications on the rating label.

16. Attach the access panel to the side of the firebox with the previously removed screws. (Fig. #27)



Note:
Gasket must be installed with access panel.

Gas Pressure Check

Note: To test the gas pressure, turn off the gas supply before removing the blanking plug from the supply pressure test port or manifold pressure test port.

Verify gas pressures with the fireplace lit and on the highest setting.

Fig #28



1. Remove the blanking plug from the pressure test port. The plug is located between the right side lintel and firebox side. (Fig. #28)

Fig #29



2. Thread the extension test fitting into the open test port. (Fig. #29)
3. Attach a pressure gauge onto the fitting.
4. When testing is complete remove the extension test fitting and replace the plug. Thread sealant will be required to ensure a gas tight connection.

Fig #29a

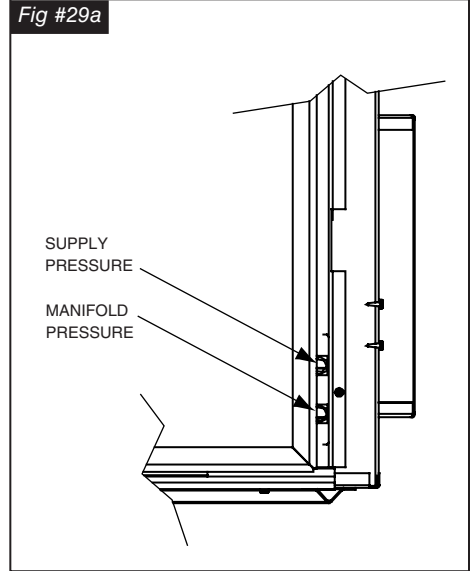

Correct gas pressure requirement:

Supply Pressure	Natural Gas	Propane
Min. Pressure <small>(For purpose of input adjustment)</small>	5.0" WC	12.5" WC
Max. Pressure	13.9" WC	13.9" WC
Manifold Pressure		
Maximum	3.8" WC	11" WC
Minimum	2.1" WC	5.5" WC

Burner Flame Adjustment

The air shutter on the burner tube controls the primary combustion air to the gas burner and is preset at the factory for natural gas fuel. Some adjustment may be necessary to obtain desired flame and to eliminate carbon deposits. Evaluate flame appearance after the fireplace has reached operating temperature. See Fig. #30 for proper flame pattern.

Open primary air shutter if the logs, glass, and firebox have carbon accumulation and/or the flames are long, dark and stringy. The shutter may also be opened to enhance the ember material glow and lessen the flame height.

Fig #30



Caution:

Proper air shutter setting is a must.

The flame should be just orange and “lazy”.

It should **NEVER** be set to create sooting on internal parts and glass.

Caution: Burner area may be hot!

Turn off the fireplace and allow the unit to cool before proceeding.

To Adjust:

1. Open and remove window frame and set aside. See “Window Frame Removal” section found in the Installation and Operating Instructions manual.
2. Remove the logs and set aside.
3. Remove air deflector from log grate (2 screws)
4. Loosen the Primary Air Shutter screw.
5. Rotate the shutter to increase or decrease the amount of primary air.
6. Reassemble in reverse order.

Replacement Parts

(WHEN ORDERING, INCLUDE PART NUMBER WITH DESCRIPTION)

ITEM.....DESCRIPTION..... PART NO.

#1..... COUNTRY HOME BURNER KIT TC30.NG02.C

#2..... 7 PCS LOG SET 5098.746148

#3..... ORIFICE, NATURAL GAS (#32) 5021.332.A
 ORIFICE, PROPANE (#48) 5021.3407

ITEM.....DESCRIPTION..... PART NO.

#4..... PILOT ASSEMBLY, CONVERTIBLE . 5005.025

#5..... MAIN SUPPLY TUBE..... 5019.223

#6..... PILOT TUBE..... 5019.225

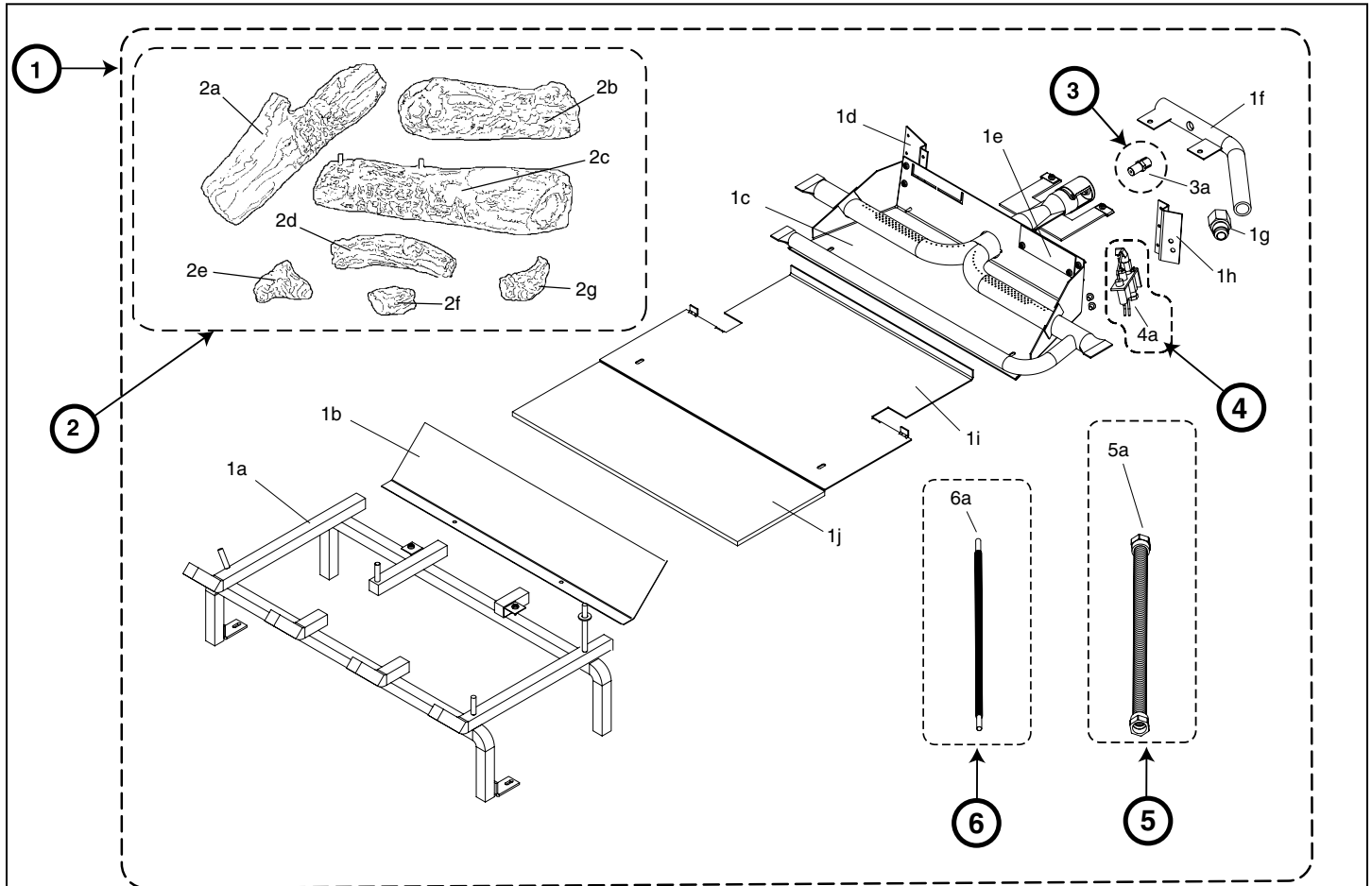

KIT CONTENTS:

#1.... BURNER ASSEMBLY

- 1a GRATE
- 1b AIR DEFLECTOR
- 1c BURNER TRAY
- 1d PILOT SHIELD
- 1e BLOCKER PLATE
- 1f MANIFOLD
- 1g 1/2 PIPE TO 1/2 TUBE CONNECTION
- 1h PILOT BRACKET
- 1i HEAT SHIELD
- 1j HEAT SHIELD INSULATION
- 2a TOP LEFT LOG
- 2b TOP RIGHT LOG
- 2c BASE LOG
- 2d CENTER CHUNK
- 2e BOTTOM LHS CHUNK

2f BOTTOM CENTER CHUNK

- 2g BOTTOM RHS CHUNK
- 3a ORIFICE, NATURAL GAS
- 3a ORIFICE, PROPANE
- 4a PILOT ASSEMBLY, CONVERTIBLE
- 5a MAIN SUPPLY TUBE
- 6a PILOT TUBE

#2.... 7 PCS LOG SET

- 2a BASE LOG
- 2b TOP LEFT LOG
- 2c TOP RIGHT LOG
- 2d CENTER CHUNK
- 2e BOTTOM LHS CHUNK
- 2f BOTTOM CENTER CHUNK
- 2g BOTTOM RHS CHUNK

#3.... ORIFICE, NATURAL GAS (#32) ORIFICE, PROPANE (#48)

#4.... PILOT ASSEMBLY, CONVERTIBLE

#5.... MAIN SUPPLY TUBE

#6.... PILOT TUBE



TOWN & COUNTRY
FIREPLACES™

Technical support: 1-877-715-2664
Web site: www.townandcountryfireplaces.net
2975 Allenby Rd., Duncan, BC V9L 6V8