

**IMPORTANT:
THESE INSTRUCTIONS ARE TO REMAIN
WITH THE HOMEOWNER**

These instructions are supplementary to the Installation and Operating Instructions supplied with the fireplace and should be kept together. Refer to the Installation and Operating Instructions for proper gas supply, safety requirements and operating instructions.



**TOWN & COUNTRY
FIREPLACES™**

TC30 BLACK DIAMOND BURNER KIT INSTRUCTIONS



**PART# TC30.NG03.C
For TC30 Series C**



Contents of Package

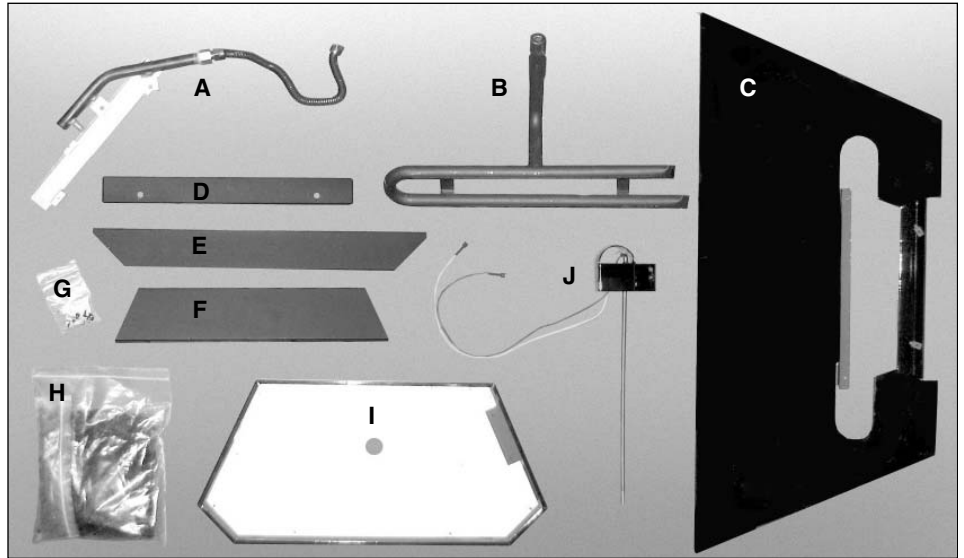

NOTE:

MUST BE USED WITH PORCELAIN PANEL SET PART# TC30.PNLPBKB

- A** MANIFOLD ASSEMBLY
(including supply tube)
- B** BURNER TUBE
- C** BURNER SHIELD
- D** MEDIA SPACER, Center
- E** MEDIA SPACER, Front
- F** MEDIA SPACER, Rear
- G** HARDWARE PACKAGE
- H** 5 lbs. GLASS MEDIA
- I** BURNER TRAY ASSY
- J** PILOT SHIELD
(including pilot and pilot supply tube)

Black Diamond Burner Installation

A porcelain panel set must be used in conjunction with the installation of the burner assembly. See Installation and Operating Instructions manual for details.

NOTE: Plug the 4 vacant holes in the bottom of the firebox with 1/2" screws, as they are not required to attach this style of burner.

1. Remove three screws from the rear of the firebox. Attach the manifold bracket to the rear of the firebox with the three screws previously removed. (Fig. #1)

INSTALL MANIFOLD ASSEMBLY

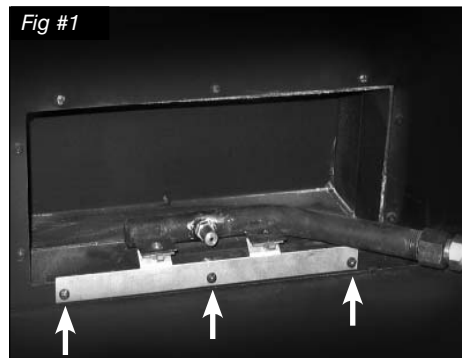

NOTE:

If unit is to be converted to Propane, see Propane conversion instructions on page 7 before proceeding.

2. Attach the manifold supply tube to the bulk head fitting and tighten. (Fig. #2) Ensure that there are no leaks.

ATTACH MANIFOLD SUPPLY TUBE



3. Attach the pilot supply tube to the bulk head fitting and tighten. (Fig. #3) Ensure there are no leaks.

ATTACH PILOT SUPPLY TUBE

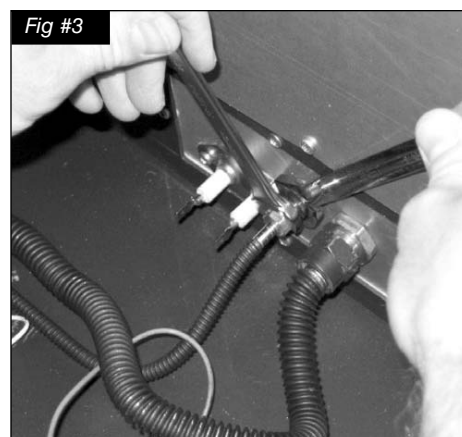

4. Attach spark electrode (ORANGE) and sensor leads to the electrical bulk head. (Fig. #4)
(The spark electrode connection is the rearmost connector.)

ATTACH SPARK ELECTRODE AND SENSOR LEADS



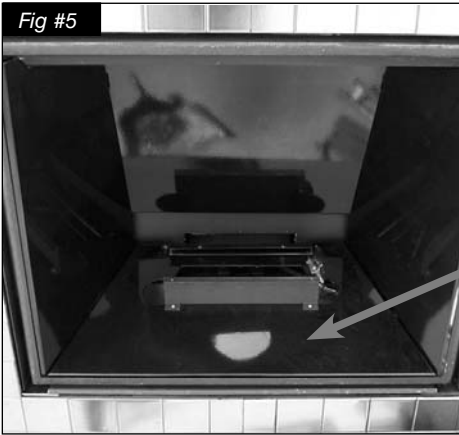

INSTALLING BURNER SHIELD

5. Install burner shield by tipping the shield into the firebox. (Fig. #5)



BURNER TRAY PLACEMENT

6. Attach the burner tray to the burner shield using two screws at the back of the tray. (Fig. #6)



PILOT SHIELD ATTACHMENT

7. Attach pilot shield to burner tray with two screws. (Fig. #7)

8. Rear and front media spacers are now installed. (Fig. #8 & 9)

REAR MEDIA SPACER



FRONT MEDIA SPACER



9. Install burner by tilting burner inlet through tray. Ensure that the orifice has entered the inlet tube. (Fig#10).

BURNER INSTALLATION

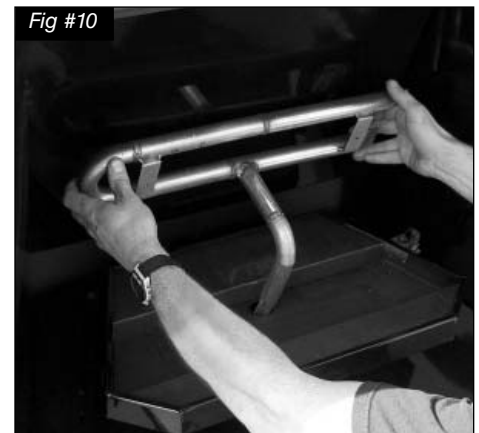

Set the air shutter to fully open for Propane or fully closed for Natural gas.

Fig #11



CENTER MEDIA SPACER

- 11. Install the center media spacer and secure to the tray with two 1 1/2" screws. (Fig. #11 & 12)
Three holes must line up to set each screw.

Fig #12



BURNER INSTALLATION

- 12. Apply just enough glass media to cover the burner assembly. (Fig #13 & 14)

NOTE: Too much tumbled glass over the burner will cause sooting with the use of propane gas.

Fig #13



GLASS MEDIA PLACEMENT

FINISHED INSTALLATION OF GLASS MEDIA

Fig #14



Propane Conversion

WARNING

This conversion kit shall be installed by a qualified service agency in accordance with the manufacturer's instructions and all applicable codes and requirements of the authority having jurisdiction.

If the information in these instructions is not followed exactly, a fire, explosion or production of carbon monoxide may result causing property damage, personal injury or loss of life.

The qualified service agency is responsible for the proper installation of this kit. The installation is not proper and complete until the operation of the converted appliance is checked as specified in the manufacturer's instructions supplied with the kit.

CAUTION

The gas supply and electrical power shall be shut off before proceeding with the conversion.

If the unit is to be used on propane convert as follows using the components supplied with this fireplace:

Note:

Factory supplied components must be used to ensure correct input. After conversion confirm proper manifold pressure.

1. Ensure the burner, pilot and gas supply are turned off, and the appliance has cooled.
2. Using a 1/2" wrench, undo the natural gas burner orifice, (marked #32). (Fig. #15)
3. Apply a small amount of pipe joint compound to the threads of the propane burner orifice (marked #48) to ensure a good seal, before screwing it into the fitting.
4. Open primary air shutter fully.
5. With a 7/16" wrench loosen the pilot head on the pilot assembly (Fig. #16)
6. Slide the pilot adjustment band over and ensure that the hole in the orifice band is showing. (Fig. #17 indicates NG position, Fig. #18 indicates LP position)
7. Remove access panel, 10 screws, and set aside

Fig #15



Fig #16

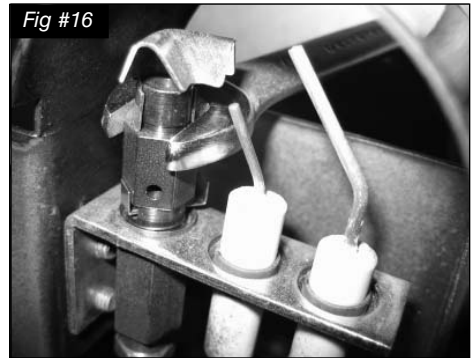

Fig #17



Fig #18



Fig #19

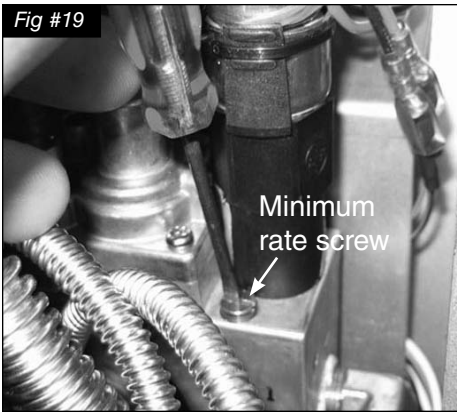

- 8. Remove the minimum rate screw located in the valve. (Fig. #19)

The minimum rate screw is sealed with an o-ring. Use a thin bladed screwdriver to back the screw out to the limit of the threads.

A groove on the screw body will be visible just above the valve body. Insert a thin tool (knife blade or thin screwdriver blade) into the groove and gently pry the screw up.

It helps to rotate the screw while lifting on it.

Fig #20

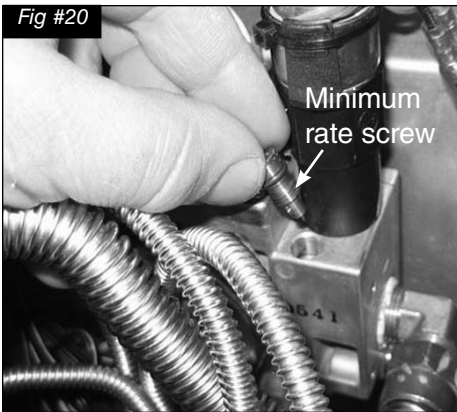

- 9. Replace the minimum rate screw with the one provided in the propane conversion kit supplied with this burner. Ensure that the screw is fully installed. (Fig. #20)

Fig #21



- 10) Pull off the rubber cap from the top of the pressure regulator. (Fig. #21)

- 11) Press down on the center post and rotate 90°. The center post should stay down. (Fig. #22). Replace the rubber cap.

Fig #22

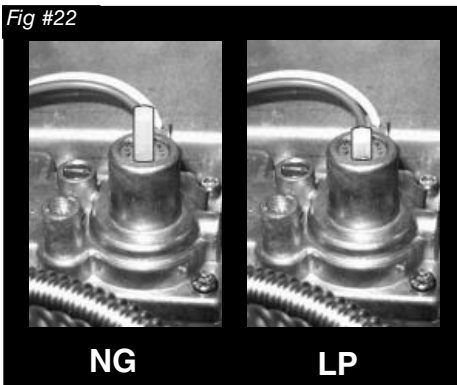

- 12) Fill in the date and the name of the person who performed the conversion in the white area on the conversion label. Peel off the protective backing and apply the conversion label directly over the gas specifications on the rating label.

- 13) Attach the access panel to the side of the firebox with the previously removed screws. (Fig. #23)

Note: Gasket must be installed with access panel.

Fig #23



Gas Pressure Check

Note: To test the gas pressure, turn off the gas supply before removing the plug from the supply pressure test port or manifold pressure test port.

Verify gas pressures with the fireplace lit and on the highest setting.



1. Remove the plug from the pressure test port using a 7/16" socket and extension. The plug is located between the right side lintel and firebox side. (Fig. #24)



2. Thread the extension test fitting into the open test port. (Fig. #25)
3. Attach a pressure gauge onto the fitting.
4. When testing is complete remove the extension test fitting and replace the plug. Thread sealant will be required to ensure a gas tight connection.

Fig #25a

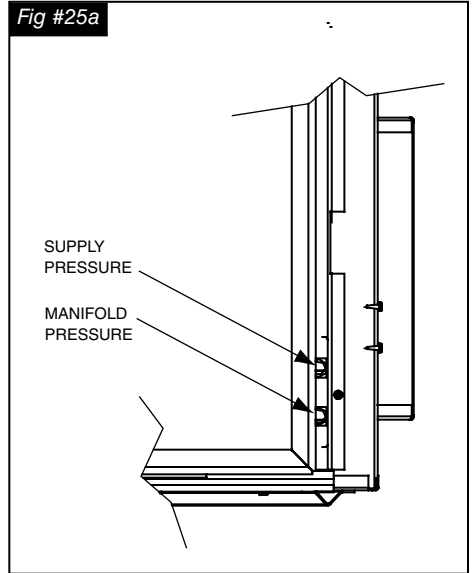

Correct gas pressure requirement:

Supply Pressure	Natural Gas	Propane
Min. Pressure (For purpose of input adjustment)	5.0" WC	12.5" WC
Max. Pressure	13.9" WC	13.9" WC
Manifold Pressure		
Maximum	3.8" WC	11" WC
Minimum	2.1" WC	5.5" WC

Burner Flame Adjustment

The air shutter on the burner tube controls the primary combustion air to the gas burner and is preset at the factory for natural gas fuel. Some adjustment may be necessary to obtain desired flame and to eliminate carbon deposits. Evaluate flame appearance after the fireplace has reached operating temperature. See Fig. #28 for proper flame pattern.

Open primary air shutter if the logs, glass, and firebox have carbon accumulation and/or the flames are long, dark and stringy. The shutter may also be opened to lessen the flame height.

The flame should be just orange and "lazy".

It should **NEVER** be set to create sooting on internal parts and window glass.

Fig #28



Replacement Parts

(WHEN ORDERING, INCLUDE PART NUMBER WITH DESCRIPTION)

ITEM	DESCRIPTION	PART NO.
#1	TC30 BLACK DIAMOND BURNER KIT	TC30.NG03.C
#2	BURNER TUBE	TC36. 5011835
#3	PILOT ASSEMBLY, CONVERTIBLE	5005.025
#4	PILOT SUPPLY TUBE	5019.225
#5	ORIFICE, NG (#32)	5021.332.A
#6	MANIFOLD SUPPLY TUBE	5019.223
#7	GLASS MEDIA	5012.01
* #8	PROPANE CONVERSION KIT	TC30.LPCE01

* NOT SHOWN

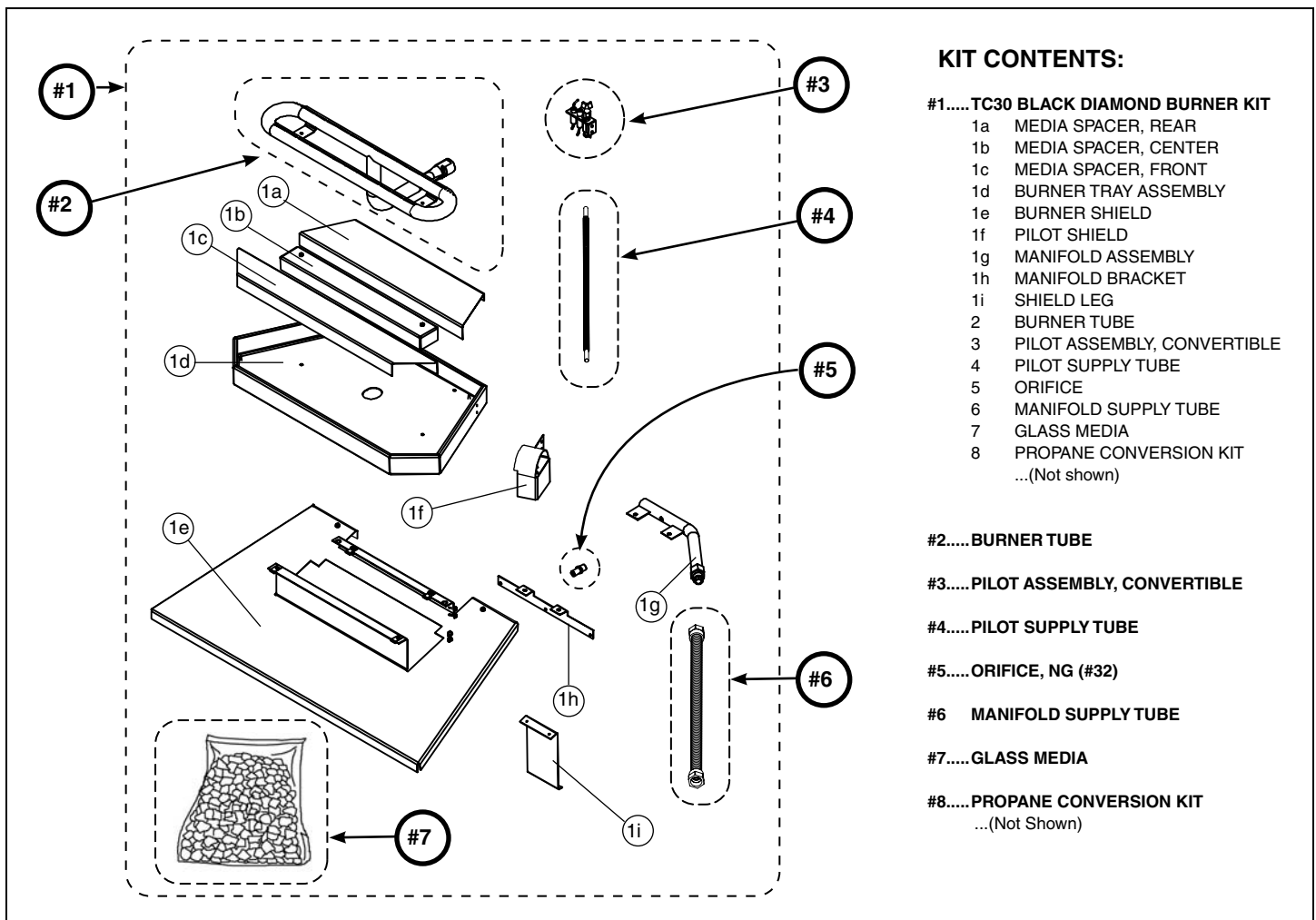

KIT CONTENTS:

- #1.....TC30 BLACK DIAMOND BURNER KIT
 - 1a MEDIA SPACER, REAR
 - 1b MEDIA SPACER, CENTER
 - 1c MEDIA SPACER, FRONT
 - 1d BURNER TRAY ASSEMBLY
 - 1e BURNER SHIELD
 - 1f PILOT SHIELD
 - 1g MANIFOLD ASSEMBLY
 - 1h MANIFOLD BRACKET
 - 1i SHIELD LEG
- 2 BURNER TUBE
- 3 PILOT ASSEMBLY, CONVERTIBLE
- 4 PILOT SUPPLY TUBE
- 5 ORIFICE
- 6 MANIFOLD SUPPLY TUBE
- 7 GLASS MEDIA
- 8 PROPANE CONVERSION KIT
...(Not shown)



TOWN & COUNTRY
FIREPLACES™

Technical support: 1-877-715-2664
Web site: www.townandcountryfireplaces.net
2975 Allenby Rd., Duncan, BC V9L 6V8