

**INSTALLER: Leave this manual with the appliance.
CONSUMER: Retain this manual for future reference.**

These instructions are supplementary to the Installation and Operating Instructions supplied with the fireplace and should be kept together. Refer to the Installation and Operating Instructions for proper gas supply, safety requirements and operating instructions



**TOWN & COUNTRY
FIREPLACES™**

TC36 COUNTRY HOME BURNER KIT INSTRUCTIONS



**PART#
TC36.NG02.C
For TC36 & 36 Arch
Series C**



Contents of Package

- 7 PCS LOG SET
- AIR DEFLECTOR
- EMBER MATERIAL
- BURNER ASSEMBLY
- LOG GRATE
- HARDWARE PACKAGE



Burner Installation

1. Attach the burner assembly to the floor shield in the bottom of the firebox with two screws. Ensure that the front edge of the burner is flush with the front of the shield.
(Fig. # 1)

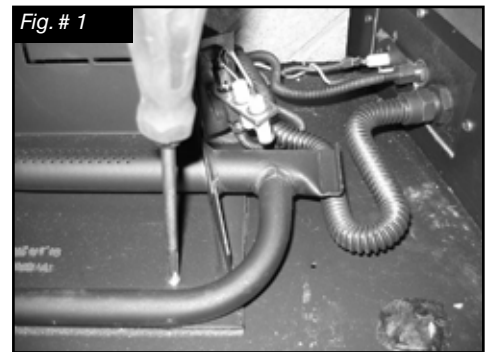

- 2) Attach spark electrode (ORANGE) and sensor leads to the electrical bulk head (Fig. # 2). (The spark electrode connection has a red dot above it).

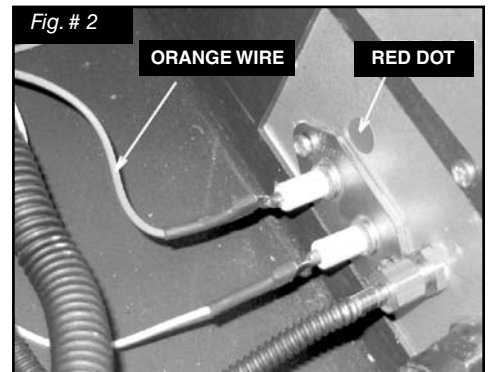
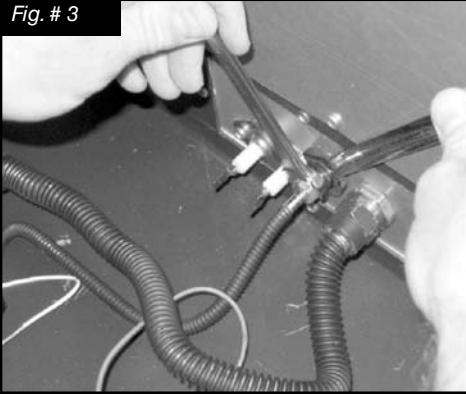

Fig. # 3



3. Attach the pilot and gas supply tubes to the bulk head fitting and tighten. (Fig. # 3) Ensure the connections are gas tight. Conceal the spark and sensor wires below the supply tubes.

A panel set must now be installed. See Installation and Operating Instructions manual for details.

Fig. # 4

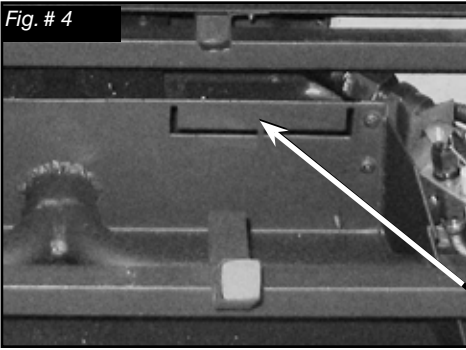

4. If this fireplace is to be fueled by propane, remove the break-away tab on the rear right hand side of the burner tray (Fig. # 4) and refer to Propane conversion instructions on Pg. 6.

REMOVE FOR LP

Fig. # 5



5. Position the slots of the grate securing brackets over the holes in the floor shield and secure with the two screws (Fig. # 5).
6. Attach rear deflector to rear of grate using the two screws provided (Fig. # 6).

Ember Material Placement

A large bag of ember material is shipped with the fireplace and needs to be installed to ensure optimum performance and flame appearance.

Pull apart the material into ember size pieces (approximately 1" squares) and gently place them into the burner pan. Do not compress, leave it loose for best performance.

Fill the burner pan level with the top of the pan at rear, and gradually slope forward to the firebox floor at the front, covering both burner tubes.

Place remaining ember material outside of the burner pan as desired to cover-up gas lines and brackets.

Note: Ember material placement and amount will affect flame appearance. More ember material results in lower flame height. Add or remove as needed until desired flame affect.

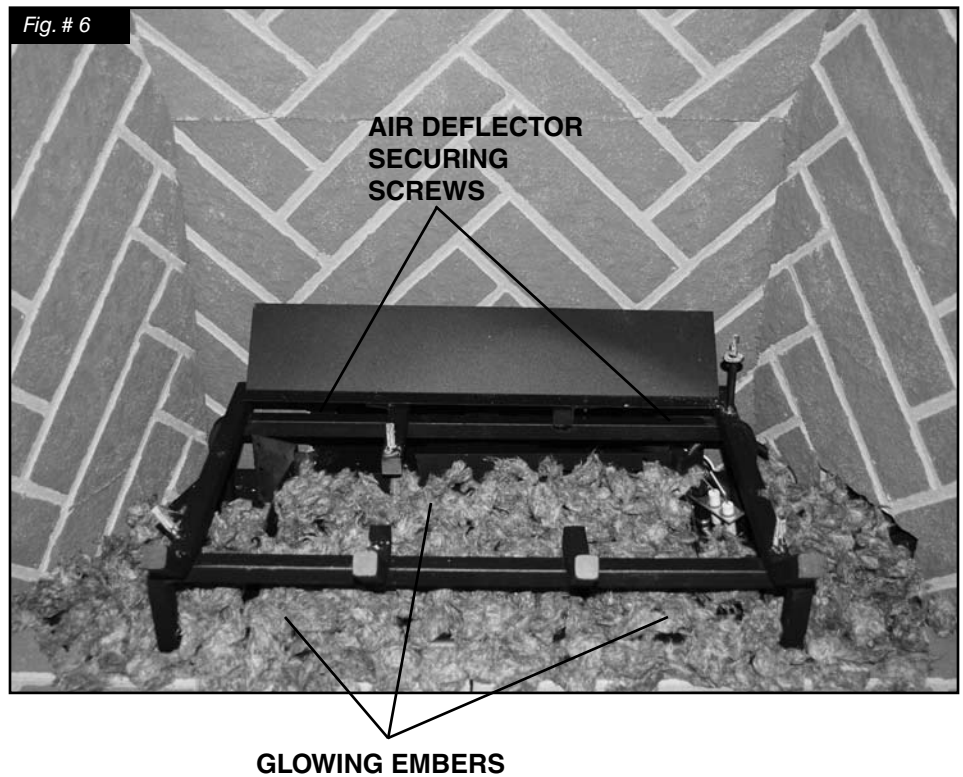

Log Placement

Gas plumbing and vent connections should be completed before proceeding.

The logs are fragile, and should be handled with care. Unpack and inspect log set. There should be a total of seven logs.

Position the logs as indicated by the following pictures. The three main logs have holes and / or pins. Engage each pin in the corresponding holes. The four smaller logs do not have holes or pins. They rest in position. Locate as per the diagrams (fig. # 7-14).

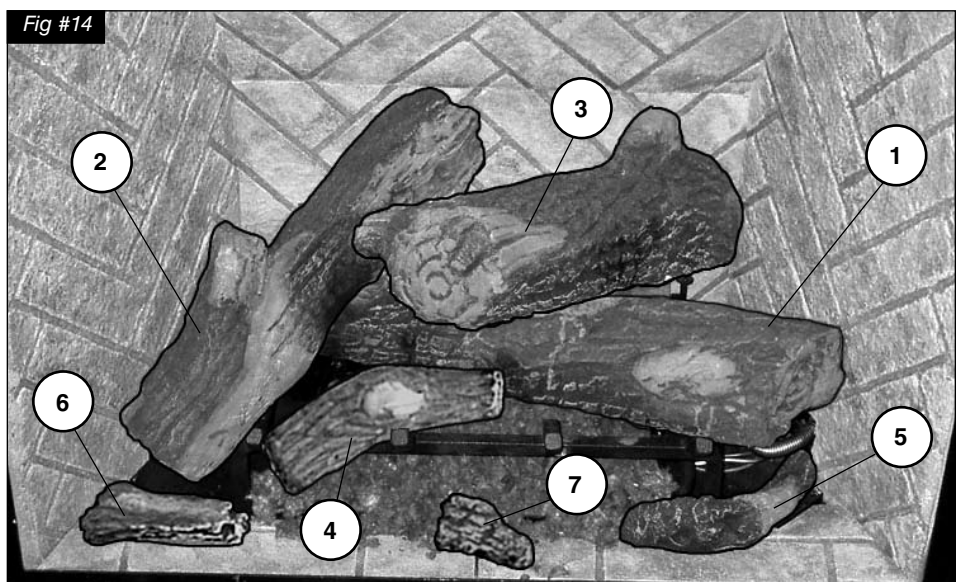
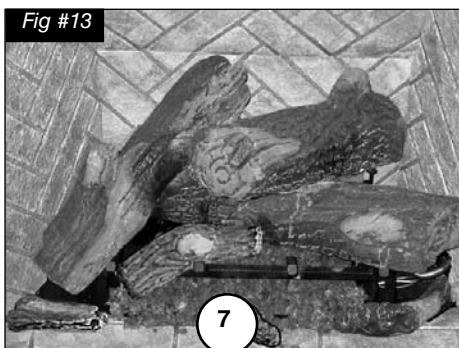
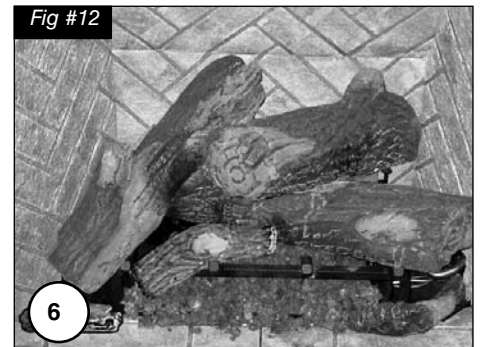
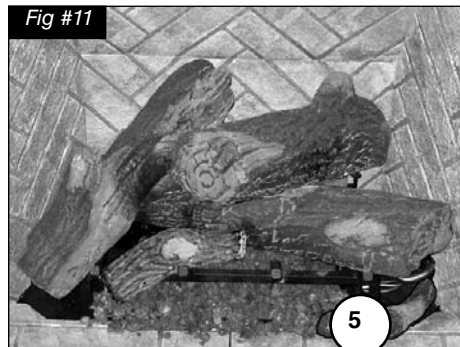
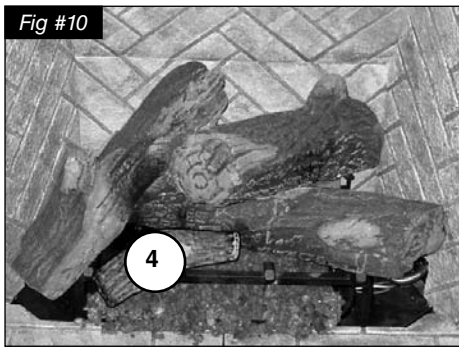
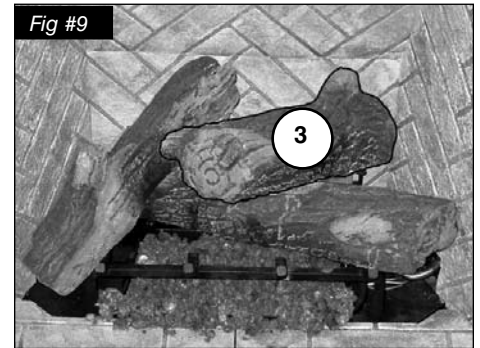
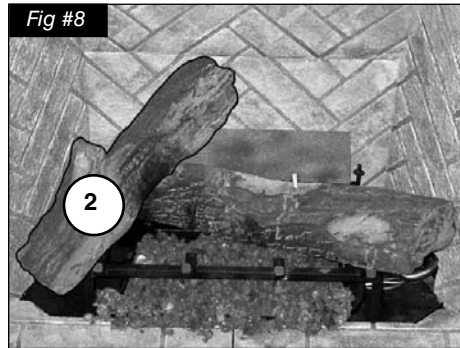
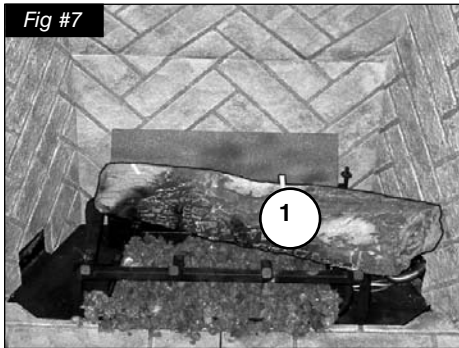

Note:
Improper placement of logs will cause sooting on internal parts and glass. The logs may need to be repositioned slightly to avoid excessive flame impingement.

Propane Conversion

WARNING

This conversion kit shall be installed by a qualified service agency in accordance with the manufacturer's instructions and all applicable codes and requirements of the authority having jurisdiction.

If the information in these instructions is not followed exactly, a fire, explosion or production of carbon monoxide may result causing property damage, personal injury or loss of life.

The qualified service agency is responsible for the proper installation of this kit.

The installation is not proper and complete until the operation of the converted appliance is checked as specified in the manufacturer's instructions supplied with the kit.

CAUTION

The gas supply and electrical power shall be shut off before proceeding with the conversion.

If the unit is to be used on propane convert as follows using the components supplied with this fireplace:

Note: Factory supplied components must be used to ensure correct input. After conversion confirm proper manifold pressure.

1. Ensure the burner, pilot and gas supply are turned off, and the appliance has cooled.
2. Remove the two screws securing the burner grate and lift out. (Fig. #14a)
3. Remove the two screws securing the manifold assembly to the burner. (Fig. #15)
4. Remove the manifold assembly from the burner. (Fig. #16)
5. If this fireplace is to be fueled by propane, remove the break-away tab on the rear right hand side of the burner tray. (Fig. #16a)
6. With a $\frac{1}{2}$ " wrench remove the natural gas orifice (#30) and replace with propane orifice (#45)(our part # 5021.34) (Fig. #17)
7. Fully open the primary air shutter.
7. Reinstall the manifold grate and air deflector.

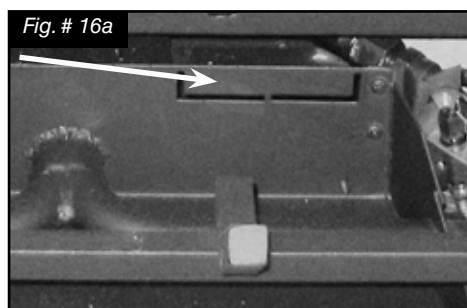
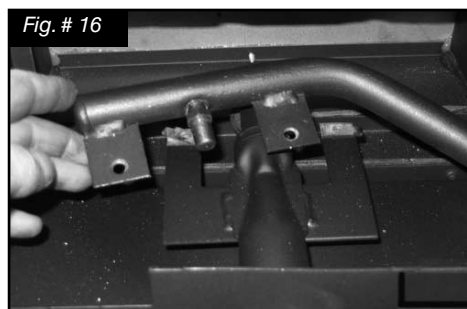
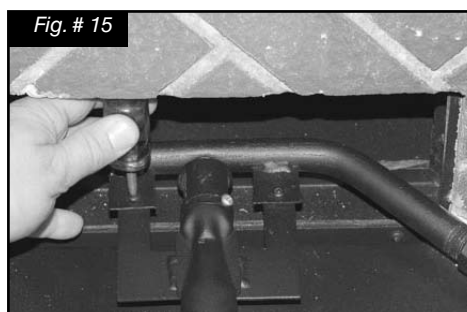
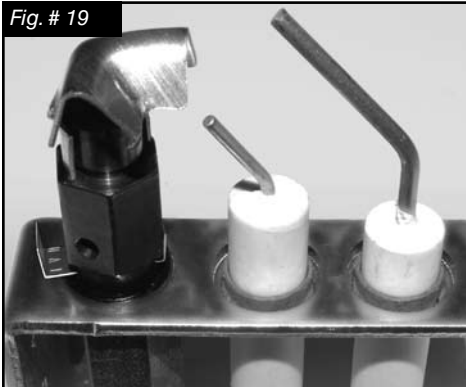

Fig. # 18



8. With a 7/16" wrench loosen the pilot head on the pilot assembly by a half-turn (Fig. #18)

Fig. # 19



9. Slide the pilot adjustment band over and ensure that the hole in the orifice band is showing. (Fig. #19 shows NG position, Fig. # 20 shows LP position)

Fig. # 20

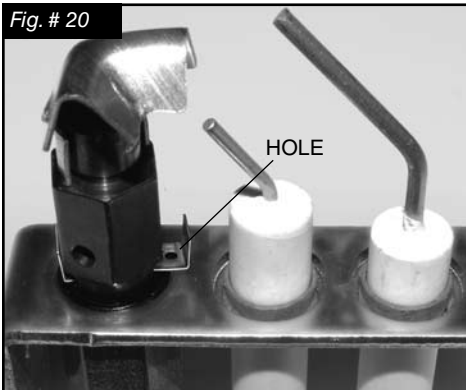
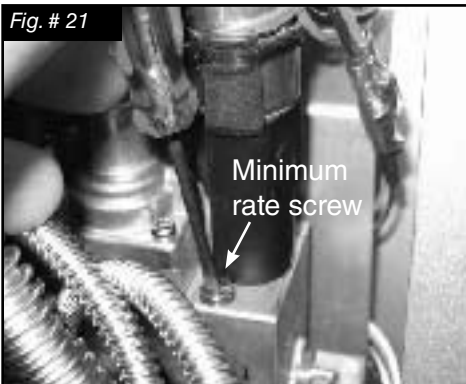

Fig. # 21



10. Remove the minimum rate screw located in the valve. (Fig. #21)

The minimum rate screw is sealed with an o-ring. Use a thin bladed screwdriver to back the screw out to the limit of the threads.

A groove on the screw body will be visible just above the valve body. Insert a thin tool (knife blade or thin screwdriver blade) into the groove and gently pry the screw up.

It helps to rotate the screw while lifting on it.

11. Replace the minimum rate screw with the one provided in the propane conversion kit supplied with this fireplace. Ensure that the screw is fully installed. (Fig. #22)



12. Pull off the rubber cap from the top of the pressure regulator. (Fig. #23)



13. Press down on the center post and rotate 90°. The center post should stay down. (Fig. #24). Replace the rubber cap.

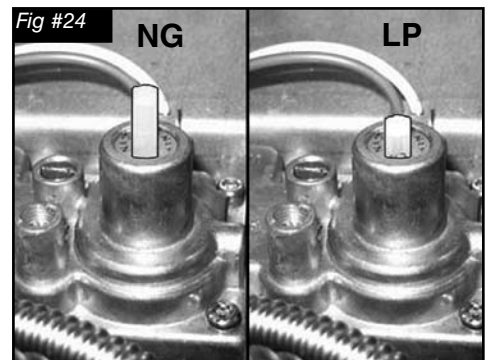

14. Fill in the date and the name of the person who performed the conversion in the white area on the conversion label. Peel off the protective backing and apply the conversion label directly over the gas specifications on the rating label.

16. Attach the access panel to the side of the firebox with the previously removed screws. (Fig. #27)

Note:
Gasket must be installed with access panel.

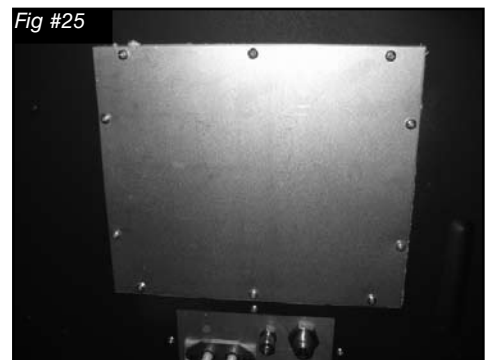

Gas Pressure Check

Note: To test the gas pressure, turn off the gas supply before removing the plug from the supply pressure test port or manifold pressure test port.

Verify gas pressures with the fireplace lit and on the highest setting.

Fig #26



1. Remove the plug from the pressure test port using a 7/16" socket and extension. The plug is located between the right side lintel and firebox side. (Fig. #26)

Fig #27



2. Thread the extension test fitting into the open test port. (Fig. #27)
3. Attach a pressure gauge onto the fitting.
4. When testing is complete remove the extension test fitting and replace the plug. Thread sealant will be required to ensure a gas tight connection.

Correct gas pressure requirement:

Supply Pressure (For purpose of input adjustment)	Natural Gas	Propane
Minimum	5.0" WC	12.5" WC
Maximum	13.9" WC	13.9" WC
Manifold Pressure		
Maximum	3.8" WC	11" WC
Minimum	2.1" WC	5.5" WC

Flame Adjustment

The air shutter on the burner tube controls the primary combustion air to the gas burner and is pre-set closed at the factory for natural gas fuel. Propane requires fully open shutter setting. Some adjustment may be necessary to obtain desired flame and to eliminate carbon deposits. Evaluate flame appearance after the fireplace has reached operating temperature. See Fig. #28 for proper flame pattern.

Open primary air shutter if the logs, glass, and firebox have carbon accumulation and / or the flames are long, dark and stringy. The shutter may also be opened to enhance the Ember Material glow and lessen the flame height.

Caution: Burner area may be hot!

Turn off the fireplace and allow the unit to cool before proceeding.

Caution: Proper air shutter setting is a must.

The flame should be just orange and "lazy". It should NEVER be set to create sooting on internal parts and glass.



To Adjust: (See Fig. #29)

1. Open and remove window frame and set aside. See "Window Frame Removal" section found in the Installation and Operating Instructions manual.
2. Remove the log set and set aside.
3. Remove the air deflector from the log grate.
4. Loosen the screw in the Primary Air Shutter.
5. Rotate the shutter to increase or decrease the amount of primary air.
6. Re assemble in reverse order.



PRIMARY AIR SHUTTER
(Shown in closed position for NG)
(Fully open shutter for Propane)

TC36.NG02.C Replacement Parts

(WHEN ORDERING, INCLUDE PART NUMBER WITH DESCRIPTION)

ITEM.....	DESCRIPTION.....	PART NO.
#1.....	COUNTRY HOME BURNER ASMBY .	TC36.NG02.C
#2.....	7 PCS LOG SET	5098.746108
#3.....	ORIFICE, NATURAL GAS	5022.13

ITEM.....	DESCRIPTION.....	PART NO.
#4.....	PILOT ASSEMBLY.....	5005.025
#5.....	MAIN SUPPLY TUBE.....	5019.223
#6.....	PILOT TUBE	5019.225
* #7.....	PROPANE CONVERSION KIT	TC36.LPCE01

* NOT SHOWN

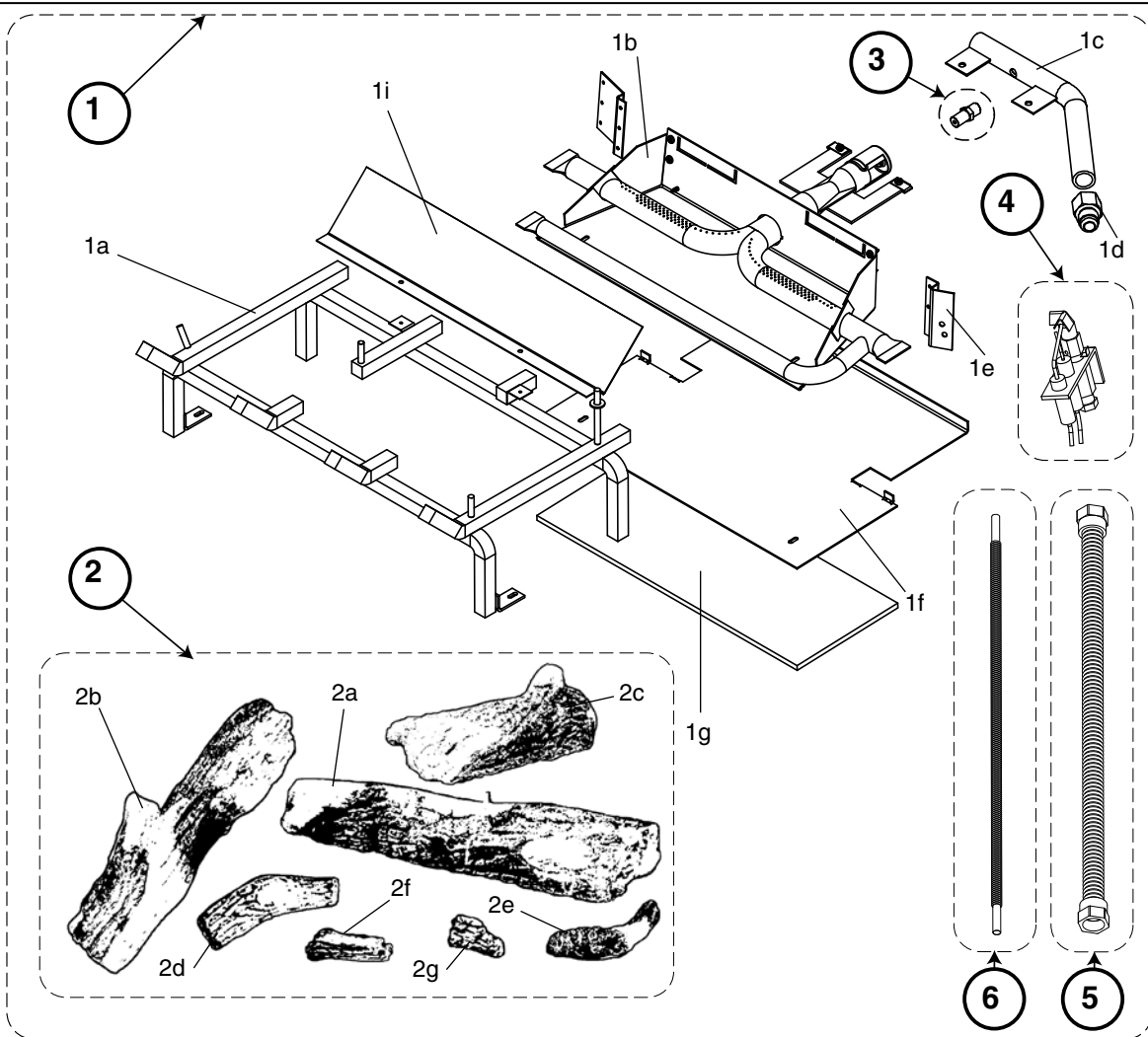

KIT CONTENTS:

#1.... BURNER ASSEMBLY

- 1a GRATE
- 1b BURNER TRAY
- 1c MANIFOLD
- 1d DORMONT FITTING
- 1e TCCV PILOT BRACKET
- 1f BURNER TRAY SUPPORT SHIELD
- 1g BURNER TRAY SHIELD GASKET
- 1i AIR DEFLECTOR
- 2a REAR LOG
- 2b LEFT LOG
- 2c RIGHT LOG

#2.... 7 PCS LOG SET

- 2a REAR LOG
- 2b LEFT LOG
- 2c RIGHT LOG
- 2d MIDDLE LOG

- 2d MIDDLE LOG
- 2e BOTTOM RIGHT CHUNK
- 2f BOTTOM LEFT CHUNK
- 2g BOTTOM CENTER CHUNK
- 3 ORIFICE, NATURAL GAS
- 4 PILOT ASSEMBLY
- 5 MAIN SUPPLY TUBE
- 6 PILOT TUBE

- 2e BOTTOM RIGHT CHUNK
- 2f BOTTOM LEFT CHUNK
- 2g BOTTOM CENTER CHUNK

#3.... ORIFICE, NATURAL GAS

#4.... PILOT ASSEMBLY, CONVERTIBLE

#5.... MAIN SUPPLY TUBE

#6.... PILOT TUBE

#7.... PROPANE CONVERSION KIT (Not shown)



**TOWN & COUNTRY
FIREPLACES™**

**TECHNICAL SUPPORT: 1-877-715-2664
townandcountryfireplaces.net
2975 Allenby Rd., Duncan, BC V9L 6V8**