



TOWN & COUNTRY
FIREPLACES™

TC42 CHALET BURNER KIT TC42.NG01.C

PACKAGE CONTENTS:

- BURNER ASSEMBLY
- LOG GRATE
- TC42 LOGS
- EMBER MATERIAL
- HARDWARE PACKAGE

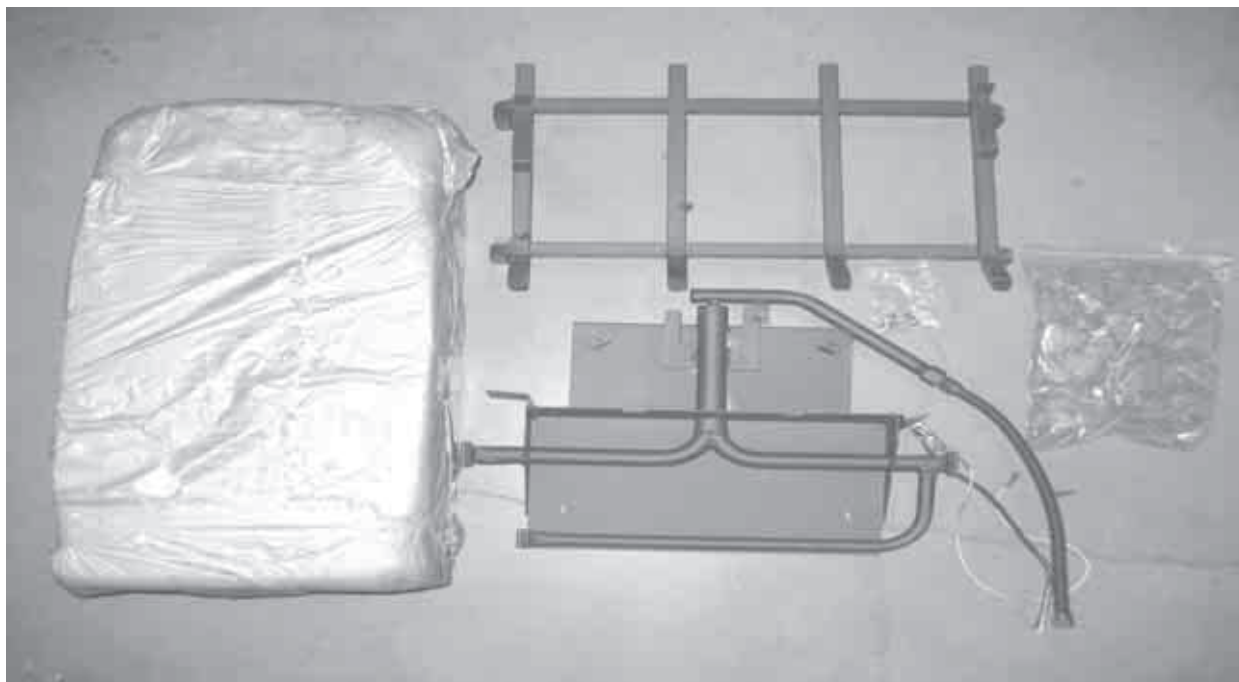

These instructions are supplementary to the Installation and Operating Instructions supplied with the fireplace and should be kept together. Refer to the Installation and Operating Instructions for proper gas supply, safety requirements and operating instructions.

**IMPORTANT: THESE INSTRUCTIONS
ARE TO REMAIN WITH THE
APPLIANCE INSTRUCTIONS**



BURNER / GRATE INSTALLATION

- 1) Attach the burner assembly to the floor of the firebox with two screws. (Fig. # 1)
- 2) Attach the manifold supply tube to the bulk head fitting and tighten. (Fig. # 2) Ensure that there are no leaks.
- 3) Attach the pilot supply tube to the bulk head fitting and tighten. (Fig. # 3) Ensure there are no leaks.
- 4) Attach spark electrode (ORANGE) and sensor leads to the electrical bulk head. (Fig. # 4) (The spark electrode connection has a red dot above it)

A panel set must now be installed. See Installation and Operating Instructions manual for details.

- 5) Position the grate in the slots of the burner tray and attach to the floor with two screws through holes located behind the front legs of the grate. (Fig. # 5)

Fig. # 1



BURNER TRAY INSTALLATION

Fig. # 2



Fig. # 3



Fig. # 4

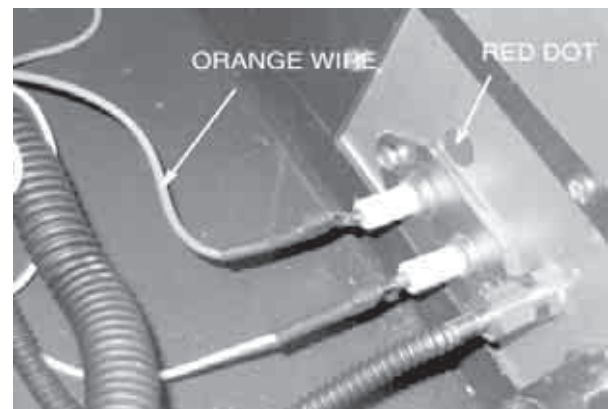

Fig. # 5



GRATE INSTALLATION

Fig. # 6

Ember Material Placement

LOG
GRATE

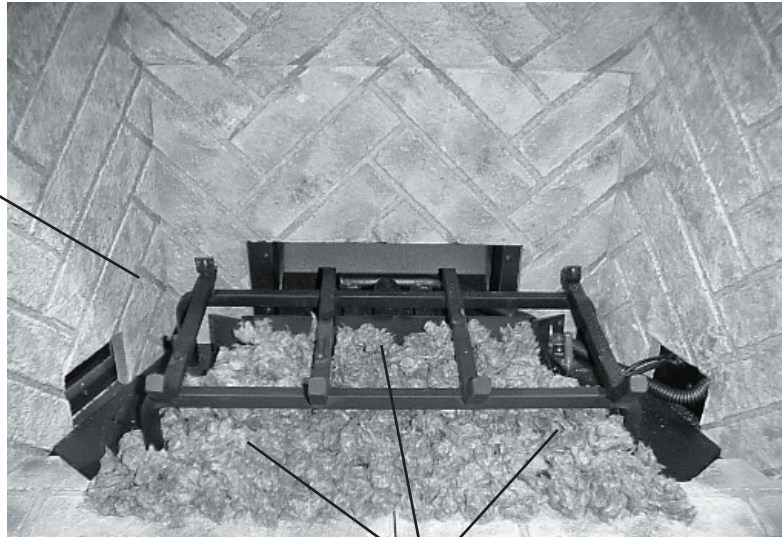

GLOWING EMBERS

EMBER MATERIAL

A large bag of ember material is shipped with the fireplace and needs to be installed to ensure optimum performance and flame appearance.

Pull apart the material into ember size pieces (approximately 1" squares) and gently place them into the burner pan. Do not compress, leave it loose for best performance. Fill the burner pan level with the top of the pan at rear, and gradually sloping forward down to the firebox floor at the front, covering both burner tubes. Place remaining ember material outside of the burner pan as desired to cover-up gas lines and brackets.

Note: Ember material placement and amount will affect flame appearance. More ember material results in lower flame height. Add or remove as needed until desired flame affect.

LOG SET ASSEMBLY

Gas plumbing and vent connections should be completed before proceeding.

The logs are packed in a foam pack inside the firebox. They are fragile, and should be handled with care. Unpack and inspect log set. There should be a total of 6 logs. Position the logs as indicated by the following pictures. Place the rear log back against the tabs located at the back of the grate. Place left log as pictured, engaging the pins with corresponding holes on the underside of the log. Install the right log into the grate and pull it forward into position as shown. Install the middle log into the space between the left log and the front of the grate as shown. Place the two remaining small logs on the floor of the firebox as shown.

Fig. # 7

Step 1

Rear Log Placement

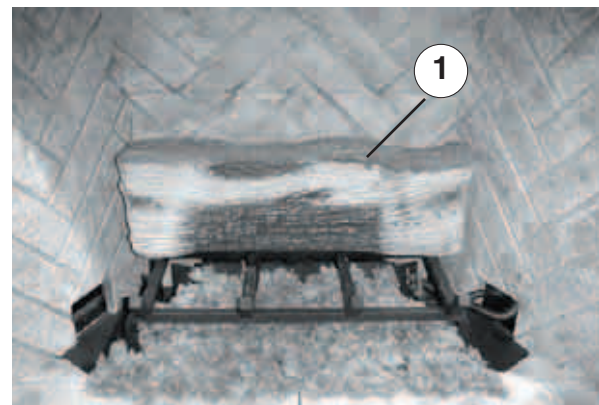

Step 2

Left Log Placement

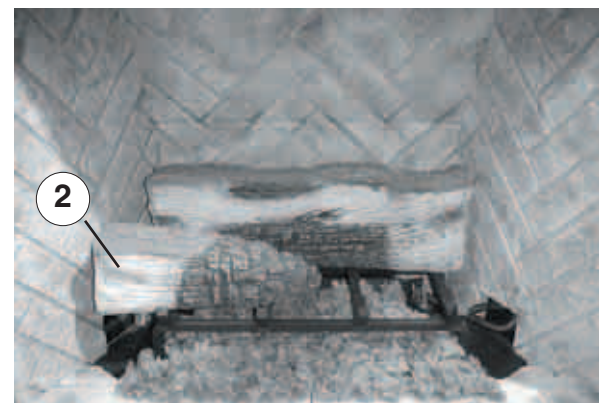

Fig. #8

Step 3
Right Log Placement

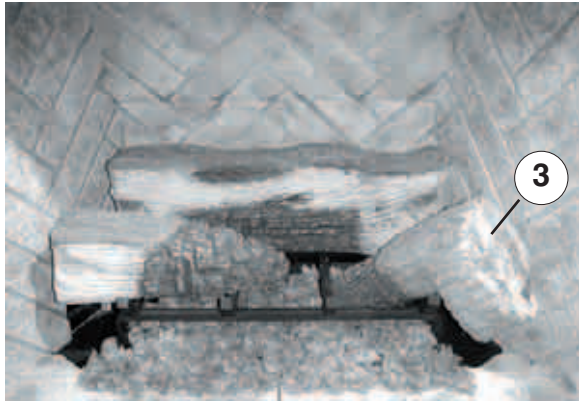
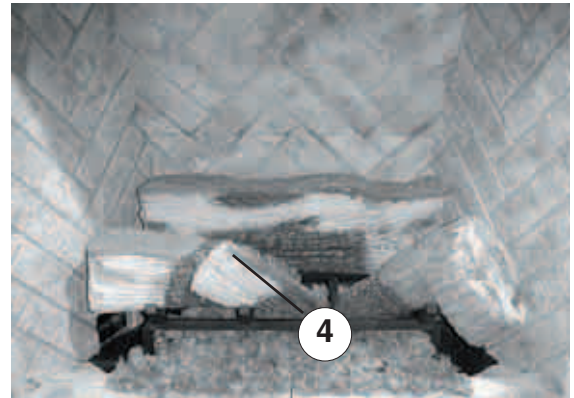
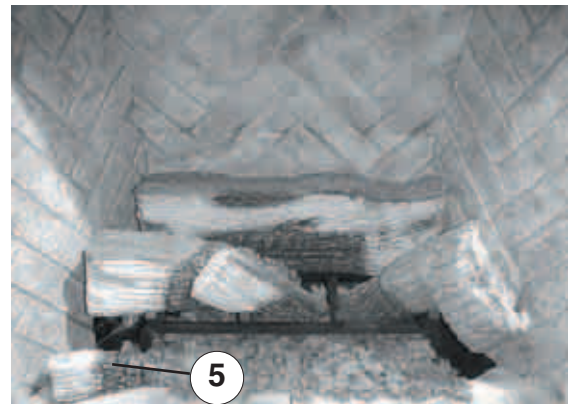

Fig. #9

Step 4
Middle Log Placement



Step 5
Bottom Left Log Placement



Note: Improper placement of logs will cause sooting on internal parts and glass. The logs may need to be repositioned slightly to avoid excessive flame impingement.

Fig. #10

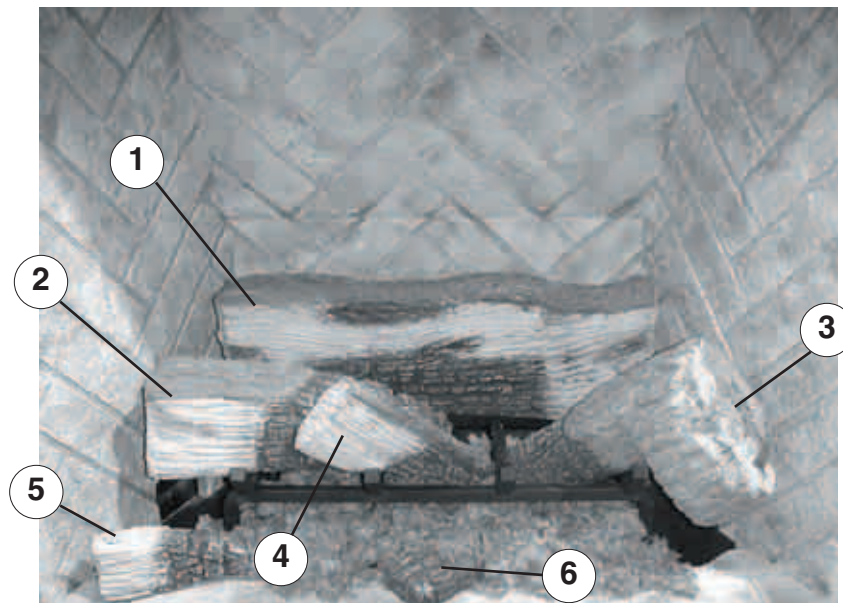

BURNER FLAME ADJUSTMENT

The air shutter on the burner tube controls the primary combustion air to the gas burner and is preset closed at the factory for natural gas fuel. Some adjustment may be necessary to obtain desired flame and to eliminate carbon deposits. Evaluate flame appearance after the fireplace has reached operating temperature. See Fig. #11 for proper flame pattern.

Open primary air shutter if the logs, glass, and firebox have carbon accumulation and / or the flames are long, dark and stringy. The shutter may also be opened to enhance the ember material glow and lessen the flame height.

Caution: Burner area may be hot!

Turn off the fireplace and allow the unit to cool before proceeding.

To Adjust: (Fig. # 12)

- 1) Open and remove window frame and set aside. See "Window Frame Removal" section found in the Installation and Operating Instructions manual.
- 2) Carefully remove the log set and set aside.
- 3) Loosen the screw in the Primary Air Shutter.
- 4) Rotate the shutter to increase or decrease the amount of primary air.

The flame should be just orange and "lazy". It should NEVER be set to create sooting on internal parts and glass.

Fig. # 12

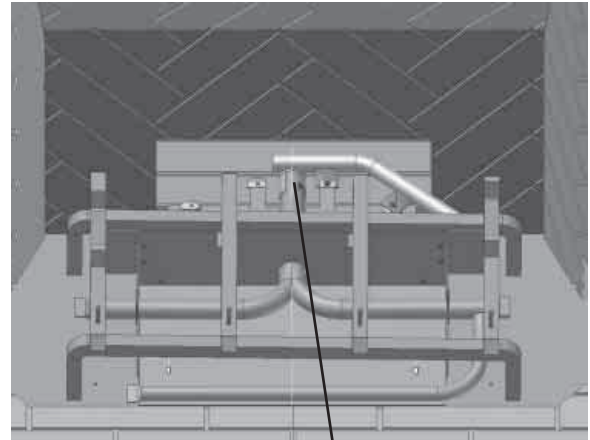

PRIMARY AIR SHUTTER

Fig. # 11



HERRINGBONE PANEL SET WITH OPTIONAL ANDIRONS SHOWN

REPLACEMENT PARTS

ITEM.....	DESCRIPTION.....	PART NO.
1.....	LOG GRATE	TC42.9081
2.....	BURNER TRAY	*TC42.908501WLD
3.....	ORIFICE, NG	5022.12
.....	ORIFICE, LP	5021.31
4.....	MANIFOLD.....	TC42.9088.1WLD
5.....	TCCV PILOT BRACKET	*9279
6.....	BURNER TRAY SUPPORT SHIELD	*9089.01
7.....	BURNER TRAY SHIELD GASKET.....	*9047
8.....	DORMONT FITTING.....	5019.221

ITEM	DESCRIPTION	PART NO.
9.....	PILOT ASSEMBLY, CONVERTIBLE.....	5005.025
10...	1/2" FLEX TUBE	5019.223
11...	1/4" FLEX TUBE	5019.225
.....	LOG SET, COMPLETE.....	5098.31061
.....	REAR, #1 (shown in fig. #10)	5098.3101
.....	LEFT, #2 (shown in fig.#10)	5098.3102
.....	RIGHT, #3 (shown in fig.#10)	5098.3103
.....	MIDDLE, #4 (shown in fig.#10).....	5098.3104
.....	BOTTOM LEFT, #5 (shown in fig.#10).....	5098.3105
.....	BOTTOM CENTRE, #6 (shown in fig.#10).....	5098.3106

*Not sold separately

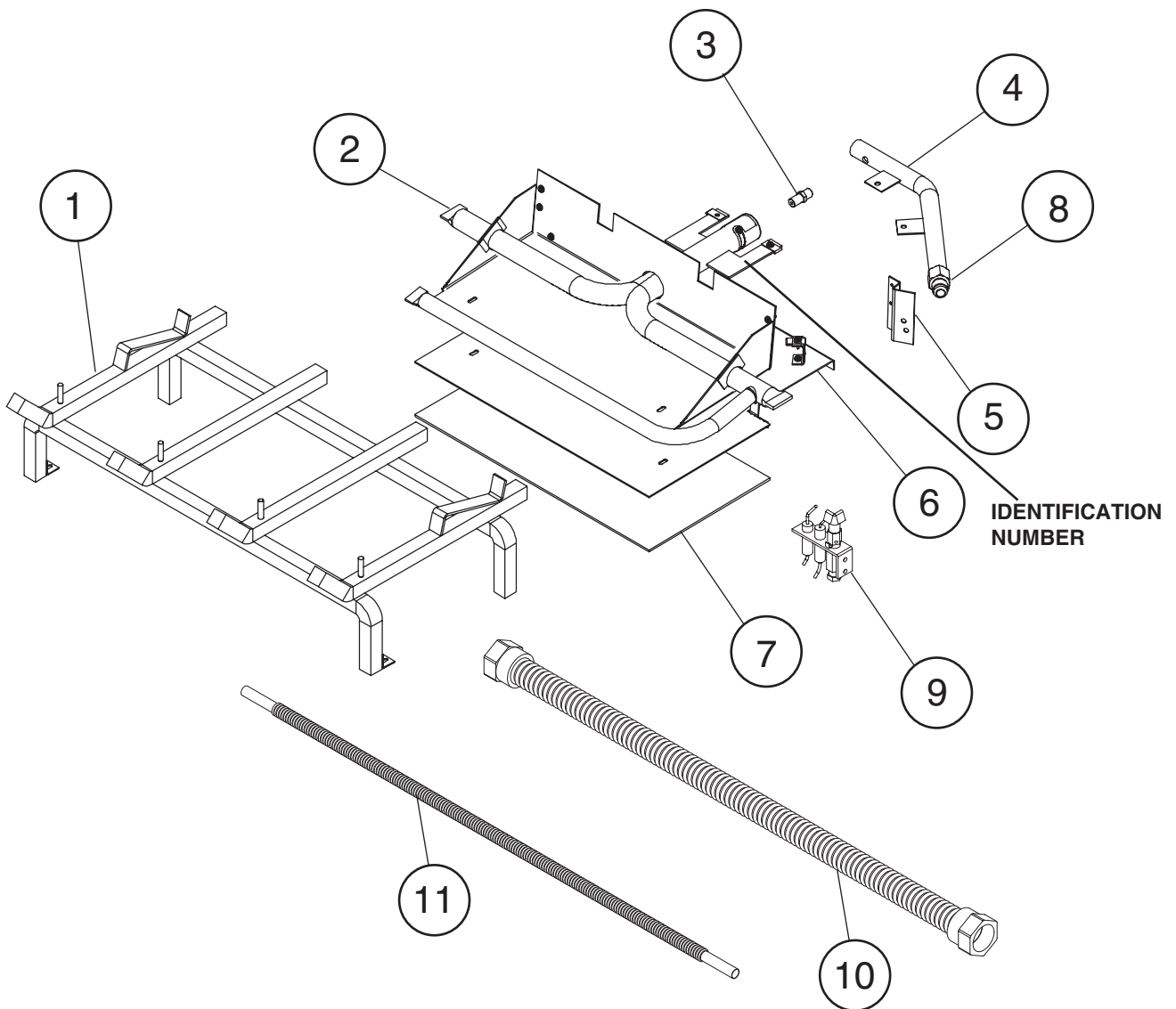

NOTES:



TOWN & COUNTRY
FIREPLACES™

TECHNICAL SUPPORT: 1-888-715-2664
www.townandcountryfireplaces.net
2975 Allenby Rd., Duncan, BC V9L 6V8