

INSTALLER: Leave this manual with the appliance.
CONSUMER: Retain this manual for future reference.

These instructions are supplementary to the Installation and Operating Instructions supplied with the fireplace and should be kept together. Refer to the Installation and Operating Instructions for proper gas supply, safety requirements and operating instructions.



**TOWN & COUNTRY
FIREPLACES™**

TCWS.54NG04.C1 TRANQUILITY BURNER KIT INSTRUCTIONS



**PART# TCWS.54NG04.C1
For TCWS Series C**



Contents of Package

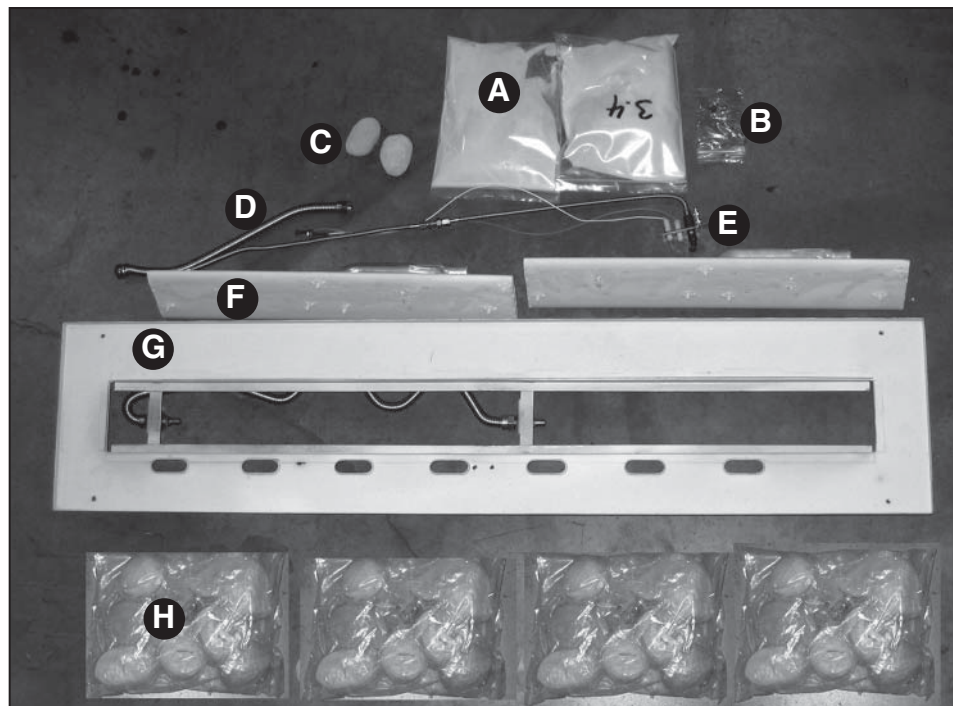

- A** 2 3.4 LBS SAND
- B** 1 HARDWARE PACK
- C** 2 EQUALIZER ROCKS
- D** 1 1/2 SS FLEX LINE
- E** 1 PILOT ASSEMBLY
- F** 2 BURNER ASSEMBLIES
- G** 1 BURNER TRAY ASSEMBLY
- H** 4 PEBBLE SETS

Tranquility Burner Installation

Fig #1

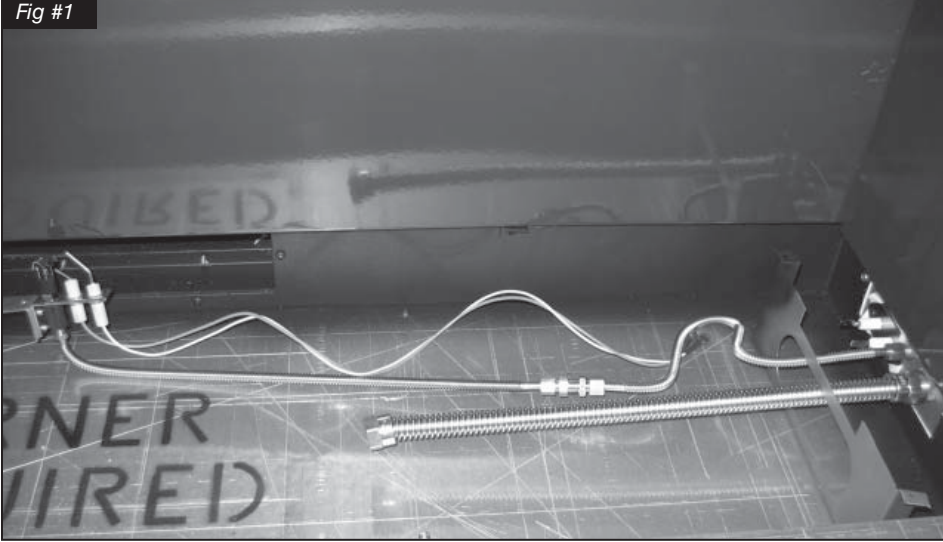

If converting to propane see conversion instructions on page #8 before proceeding.

Install panels according to the TCWS.54CE Installation and Operating manual prior to burner installation. (Page 23)

1. Attach fuel flex line and pilot assembly to bulkhead fittings. (Fig. #1)

Fig #2

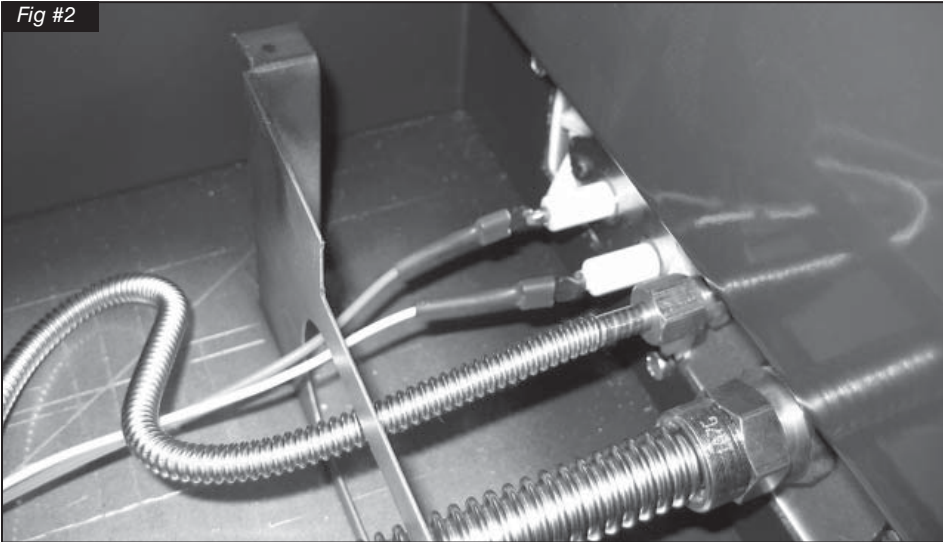

2. Connect spark electrode wire (ORANGE) to the rear electrical bulk head fitting. Connect the flame sensor wire to the front electrical bulk head fitting. (Fig. #2)

Fig #3

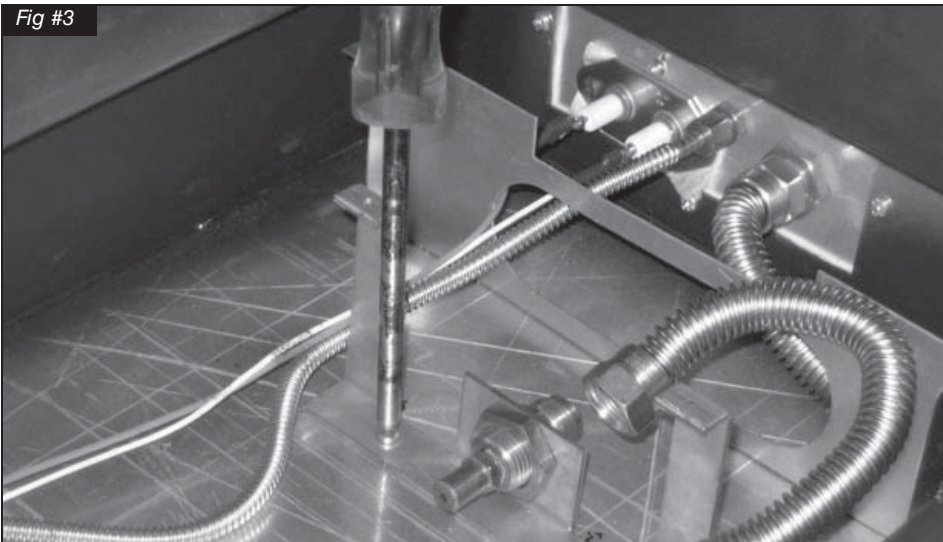

3. Attach both manifold brackets to the bottom of the firebox using four screws. (Fig. #3)

4. Connect gas lines to both orifice assemblies on the mounting brackets. (Fig. # 4)

CAUTION: Ensure that all connections are gas tight.

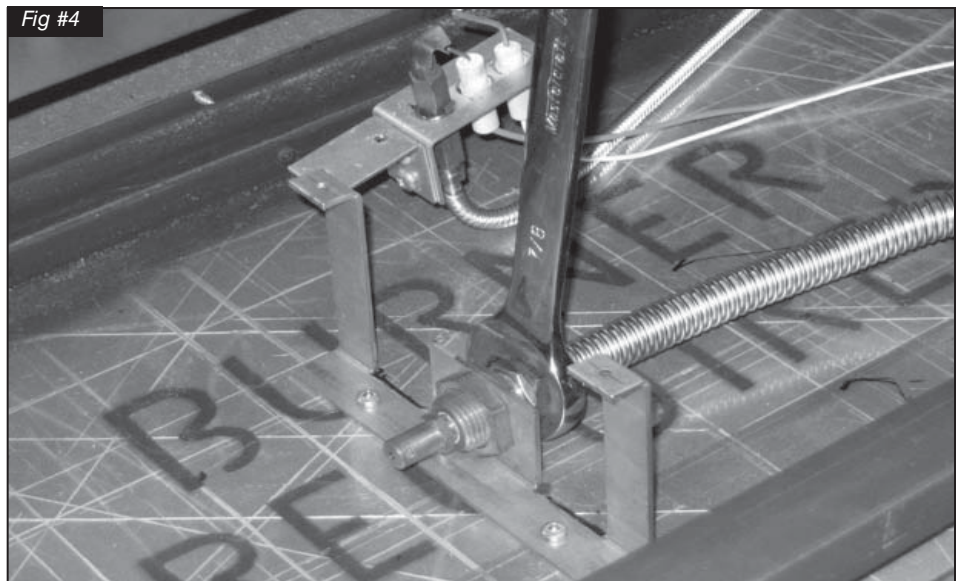

5. Tilt burner tray length-wise and insert into the firebox. (Fig. #5)

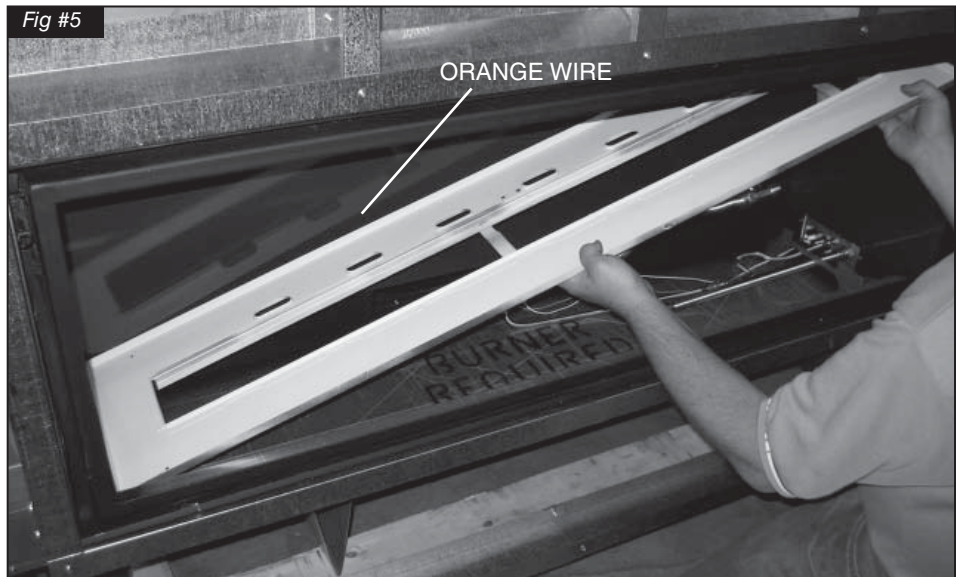

6. Attach pilot to burner tray. (Fig. #6)

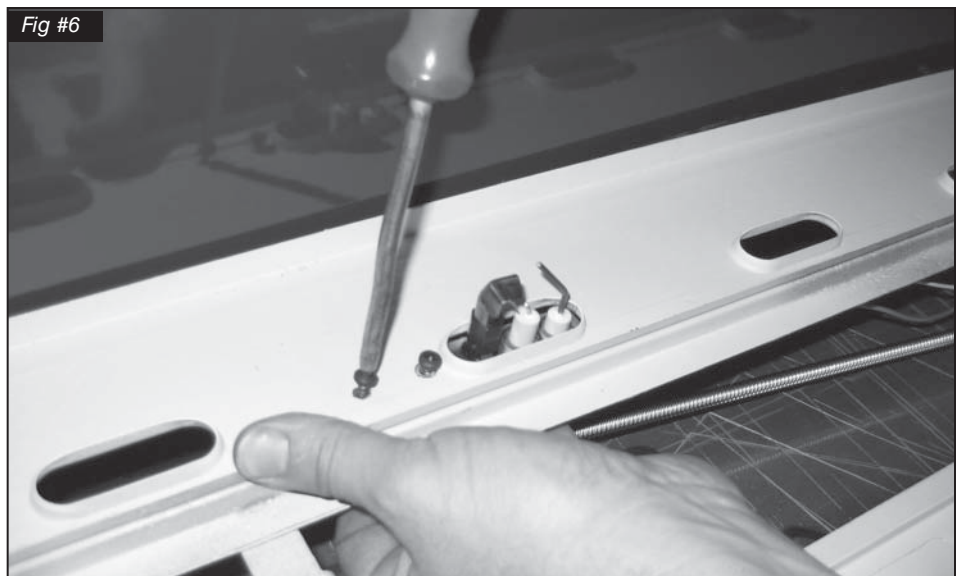

Fig #7



7. Secure the burner tray to legs using four screws (Fig. #7)

NOTE: a light will aid aligning the holes in the tray with the leg

Fig #8



NOTE: check air shutter for correct fuel setting before proceeding further. Both burners are the same. Fully closed for natural gas. 13/64 (0.2)" open for LP.

8. Install the right burner by tipping into location trough and slipping the venturi tube over the orifice. Test for connection by lifting at a location pin on the right side of the burner. Repeat with left burner. (Fig. #8)

Fig #9



CAUTION: The burners should be tightly butted up against each other at the center to ensure correct operation.

9. Place sand into the burner tray and brush smooth. Use caution not to get sand near the burner ports. (Fig. #9)

10. Each rock has a slot in its base and is marked with a letter and an arrow. (Fig. #10)

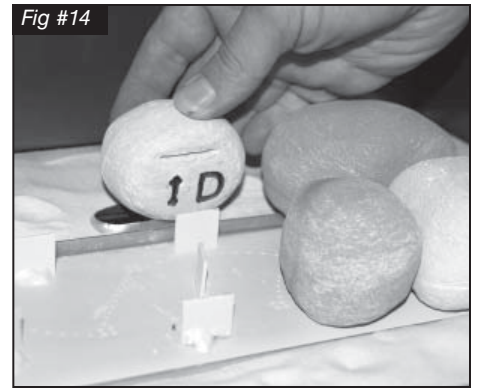

11. Place each rock as per the following photographs, start from the right hand side of the burner and ensure that the arrow on each rock points towards the front of the fireplace. (Fig. #11 to 22)

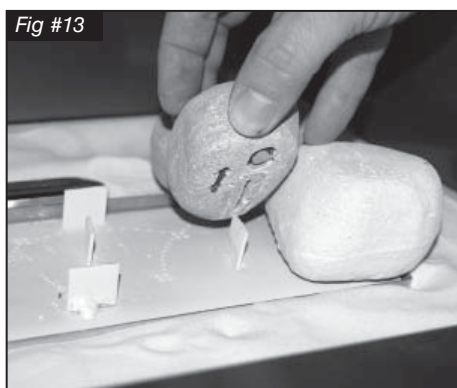
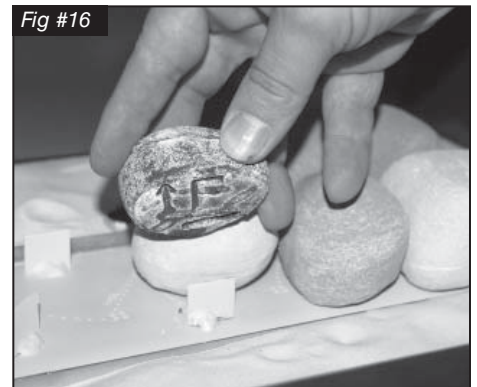
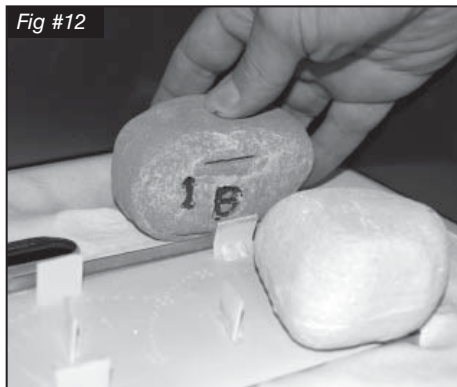
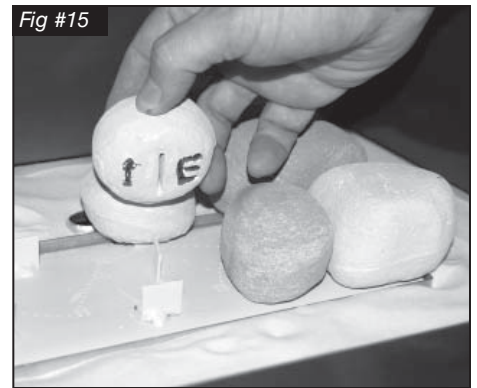
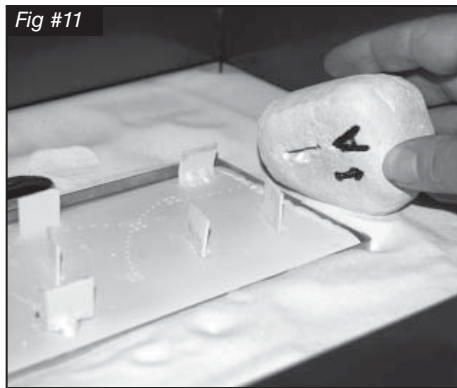

Fig #18

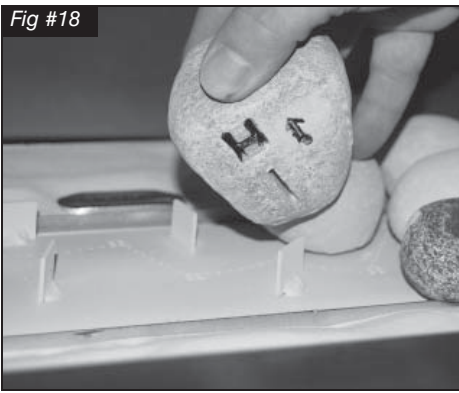
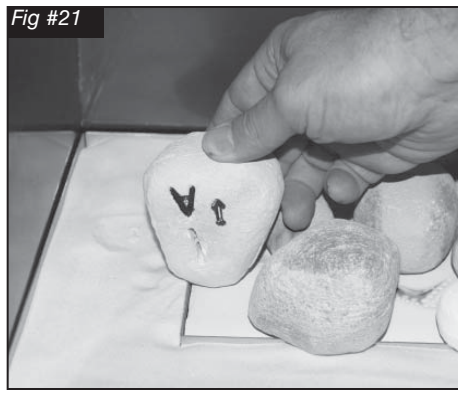

Fig #21



- Place the two remaining rocks on the left hand end of burner as shown. (Fig. #21 and 22)

Fig #19

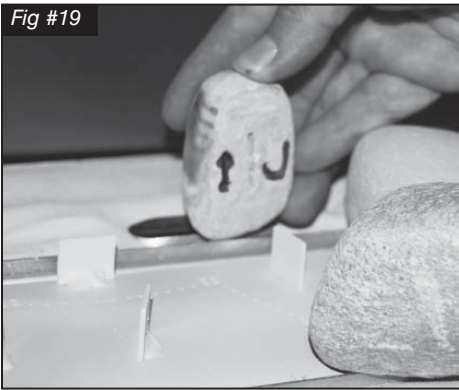

Fig #22



- Repeat the sequence of placing the rocks three more times until the burner is covered.

Fig #20

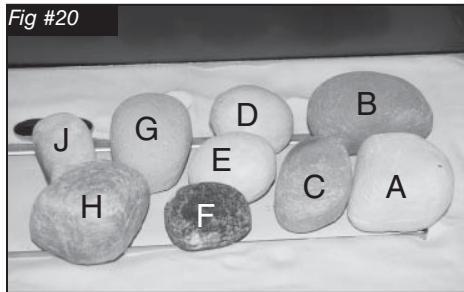
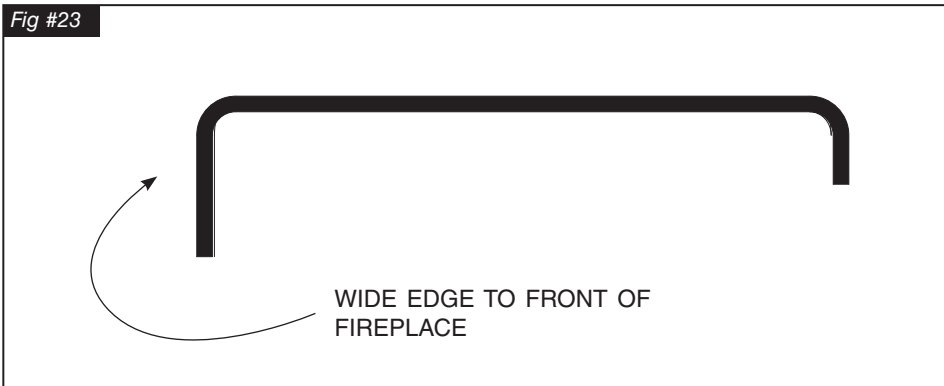

Fig #23



- Install front porcelain cover (wide edge should face the front). (Fig. #23)

Propane Conversion

If the unit is to be used on propane convert as follows using the components supplied with this burner:

CAUTION

The gas supply and electrical power shall be shut off before proceeding with the conversion.

Note:

Factory supplied components must be used to ensure correct input. After conversion confirm proper manifold pressure.

WARNING

This conversion kit shall be installed by a qualified service agency in accordance with the manufacturer's instructions and all applicable codes and requirements of the authority having jurisdiction.

If the information in these instructions is not followed exactly, a fire, explosion or production of carbon monoxide may result causing property damage, personal injury or loss of life.

The qualified service agency is responsible for the proper installation of this kit.

The installation is not proper and complete until the operation of the converted appliance is checked as specified in the manufacturer's instructions supplied with the kit.

Fig #23a

PROPANE CONVERSION KIT

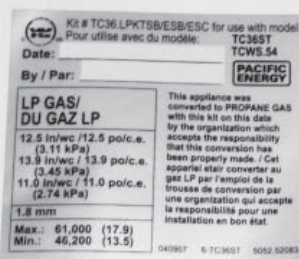

CONVERSION LABEL (5052.5283)

MINIMUM RATE SCREW (5005.16)

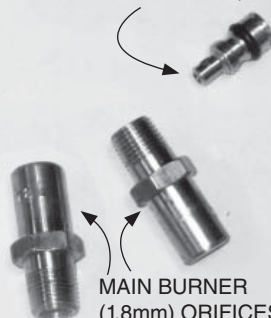

MAIN BURNER (1.8mm) ORIFICES (5022.85)

1. If installed remove the rocks from the burners.
2. If installed remove the burner from the burner tray by gently lift up the left side of the burner and disengage the burner tube from the orifice. (Fig. #24)
3. Using a 1/2" wrench, undo the natural gas burner orifice, (marked #32). Apply a small amount of pipe joint compound to the threads of the propane burner orifice (marked 1.8mm) to ensure a good seal, before screwing it into the fitting.

Loosen the primary air shutter screw, open shutter to give a gap of 13/64" (0.2") and re-tighten. Repeat on other burner. (Fig. #26)

4. With a 7/16" wrench loosen the pilot head on the pilot assembly. (Fig. #27)

Fig #24



Fig #25

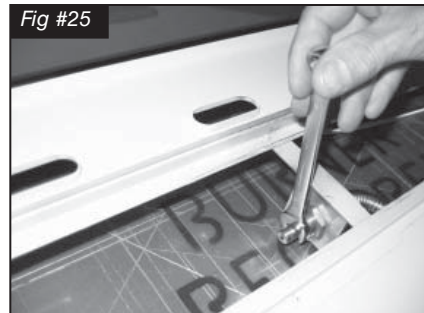

Fig #26

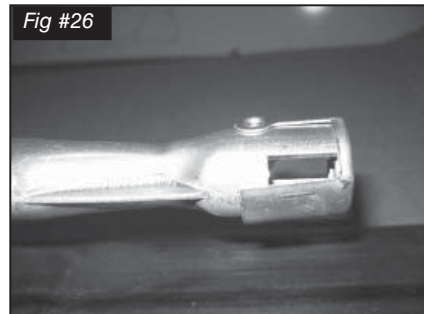
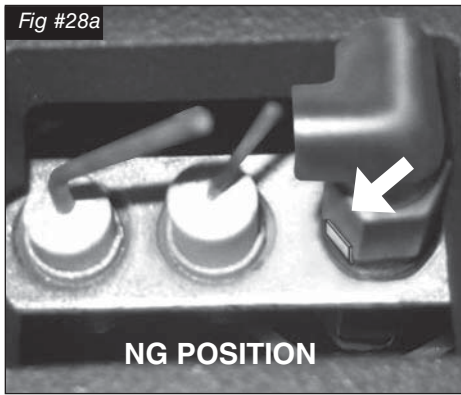

Fig #27





- Slide the pilot adjustment band over and ensure that the hole in the orifice band is showing.

◀ Fig. #28a shows NG position
 Fig. #28b shows LP position). ▶

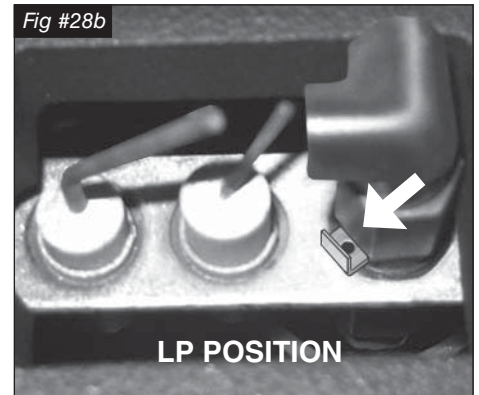

- Remove the access panel, 10 screws, and set aside.

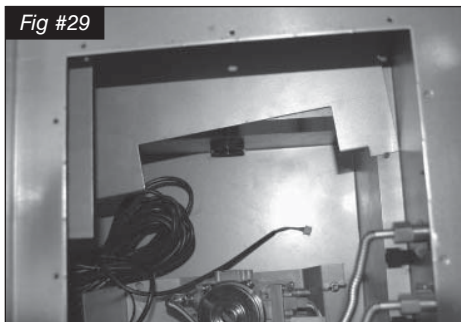

- Lift the control box shield and rest on the edge of the screw above the access hole (Fig. #29)

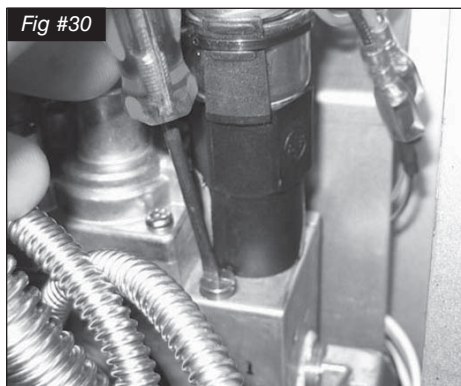

- Remove the minimum rate screw located in the valve. (Fig. #30)

The minimum rate screw is sealed with an O-ring. Use a thin bladed screwdriver to back the screw out past the limit of the threading. At this point a groove on the screw body will be visible just above the valve body. Insert a thin tool (knife blade or fine screwdriver blade) into the groove and gently pry the screw up. It helps to rotate the screw while lifting on it.

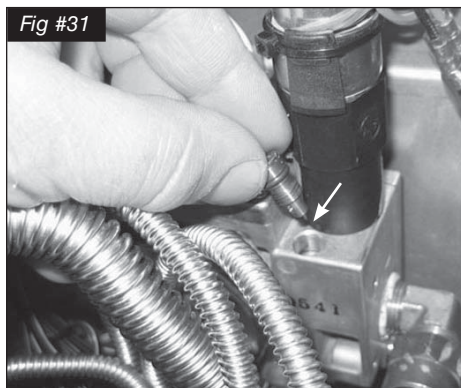

- Replace the minimum rate screw with the one provided in the propane conversion kit supplied with this fireplace. Ensure that the screw is fully seated. (Fig. #31)

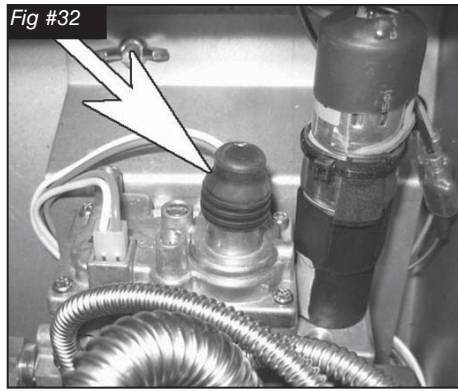

10. Pull off the rubber cap from the top of the pressure regulator. (Fig. #32)

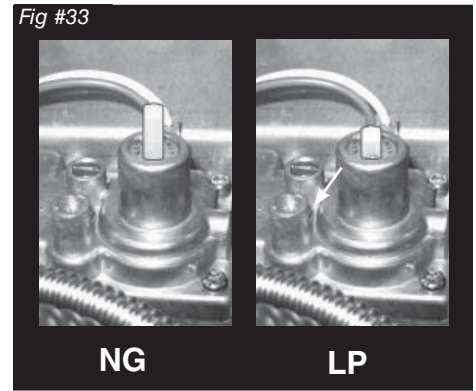

11. Press down on the center post and rotate 90°. The center post should stay down. (Fig. #33). Replace the rubber cap.

12. Check all connections for leaks

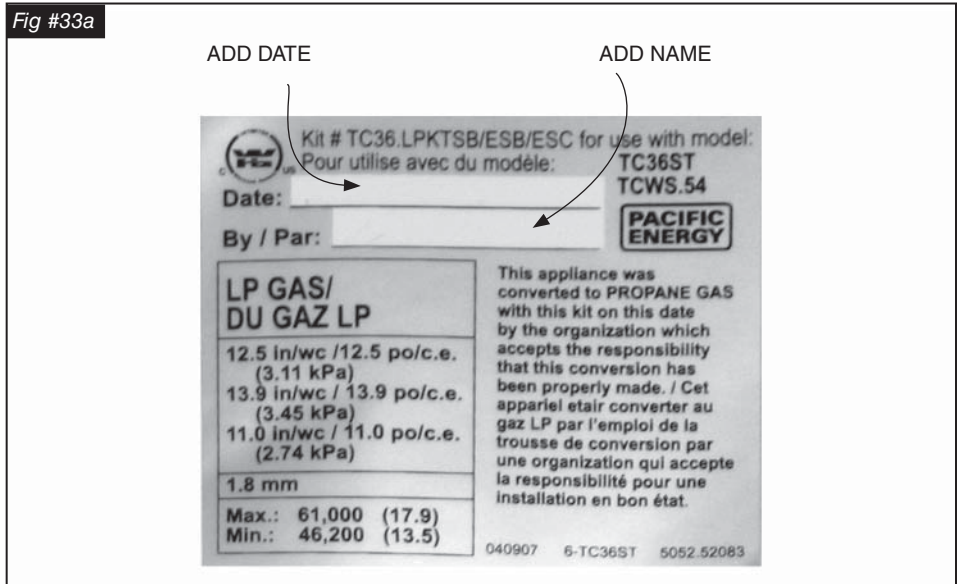

13. Fill in the date and the name of the person who performed the conversion in the white area on the conversion label. Peel off the protective backing and apply the conversion label directly over the gas specifications on the rating label.

WARNING: Both the control box shield and the access panel must be reinstalled after conversion/ installation or servicing has been completed. Failure to do so will overheat and cause premature failure of the control system.

CONTROL SHIELD SHOWN IN PROPER CLOSED POSITION

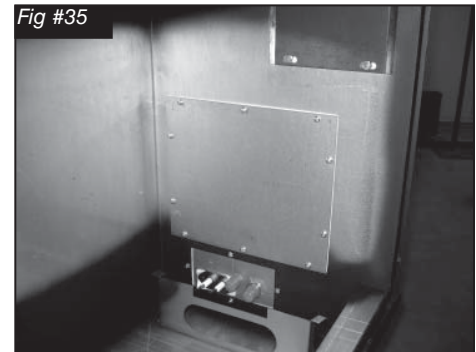
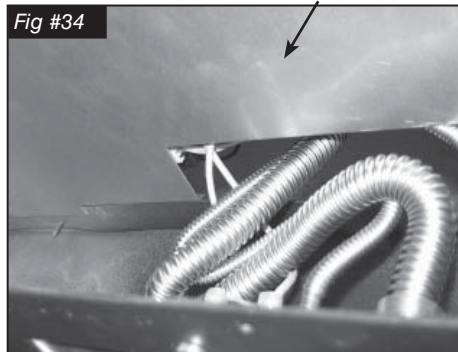

14. Re locate the control box shield and re-attach the access panel to the side of the firebox with the screws previously removed. (Fig. #34 & 35)

Gas Pressure Check

Note: To test the gas pressure, turn off the gas supply before removing the plug from the supply pressure test port or manifold pressure test port.

Verify gas pressures with the fireplace lit and on the highest setting.

Fig #37



1. Remove the plug from the pressure test port using a 3/16" hex key. The plug is located between the right side lintel and firebox side. (Fig. #37)

Fig #36

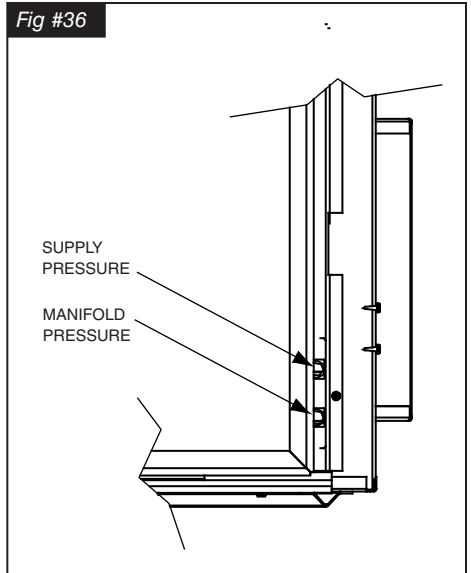

Fig #38



2. Thread the extension test fitting into the open port. (Fig. #38)
3. Attach a pressure gauge onto the fitting.
4. When testing is complete shut off the gas, remove the fitting and replace the plug. Thread sealant will be required to ensure a gas tight connection.

Correct gas pressure requirement:

Supply Pressure	Natural Gas	Propane
Min. Pressure <small>(For purpose of input adjustment)</small>	5.0" WC	12.5" WC
Max. Pressure	13.9" WC	13.9" WC
Manifold Pressure		
Maximum	3.8" WC	11" WC
Minimum	2.1" WC	5.5" WC

Burner Flame Adjustment

The air shutter on the burner tube controls the primary combustion air. It is set to the closed position at the factory for natural gas fuel. For LP see Pg.8. Some adjustment may be necessary to obtain desired flame and to eliminate carbon deposits. Evaluate flame appearance after the fireplace has reached operating temperature. See Fig. #39 for proper flame pattern.

Open primary air if the window glass and firebox have carbon accumulation and/or the flames are long, dark and stringy. The shutter may also be opened to lessen the flame height.

Fig #39



NOTE:
Proper air shutter setting is required.

The flame should be just orange and “lazy”. It should NEVER be set to create sooting on internal parts and window glass.

Replacement Parts

(WHEN ORDERING, INCLUDE PART NUMBER WITH DESCRIPTION)

ITEM.....	DESCRIPTION.....	PART NO.
#1.....	TRANQUILITY BURNER KIT.....	TCWS.54NG04.C
#2.....	PEBBLE ASSEMBLY	5096.921
#3.....	MAIN SUPPLY TUBE.....	5019.223
#4.....	PILOT ASSEMBLY.....	TCRP.5005025C
#5.....	ORIFICE, NATURAL GAS (#32).....	5021.332.A

ITEM.....	DESCRIPTION.....	PART NO.
* #7.....	PROPANE CONVERSION KIT.....	TC36.LPCSTE01
* #8.....	SAND	TC42.SAND34 (Two Bags Per Kit)
* #9.....	TRIM ROCK "A".....	5096.922
* #10.....	TRIM ROCK "B".....	5096.923

* NOT SHOWN

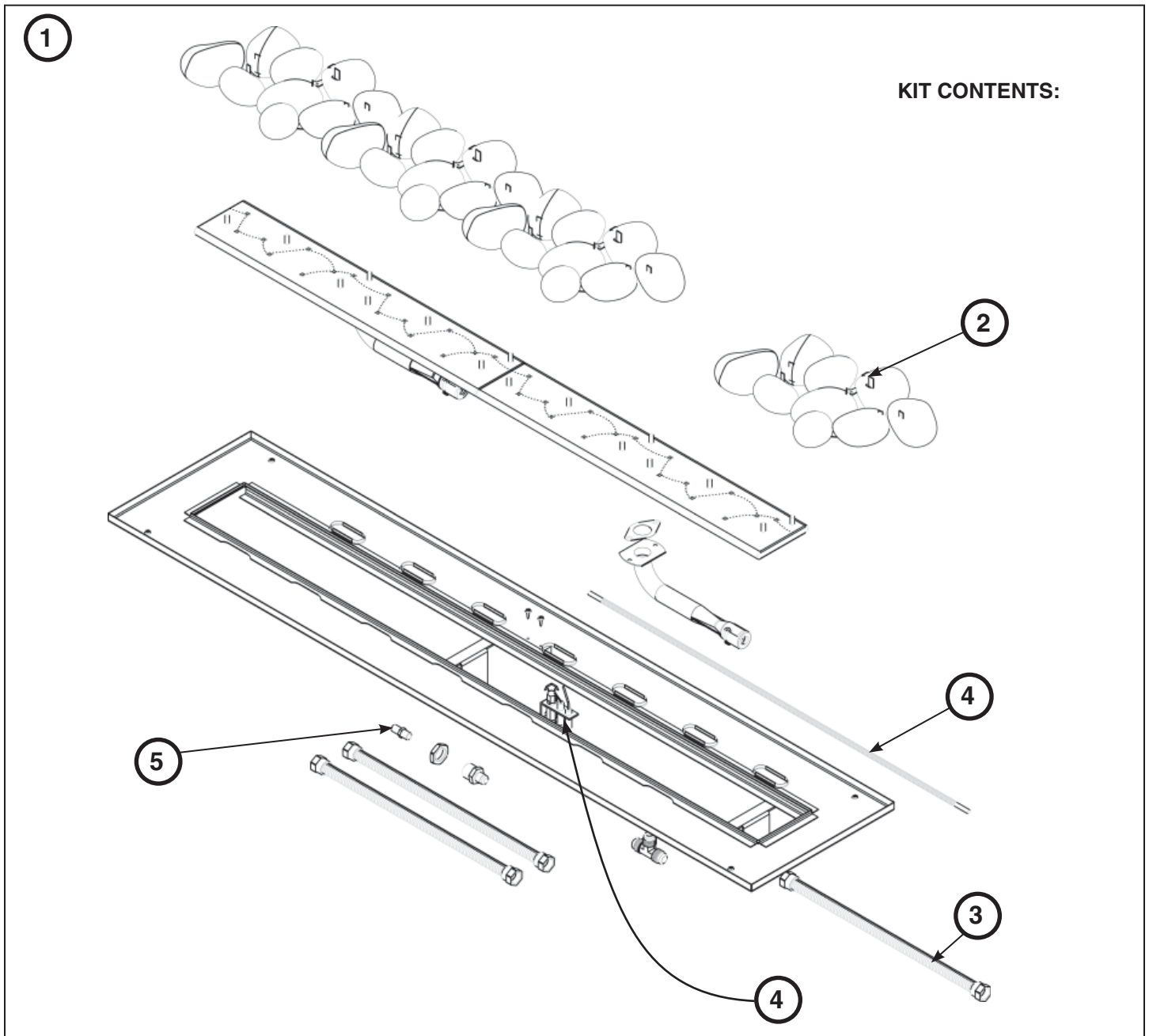

Notes:

Notes:



TOWN & COUNTRY
FIREPLACES™

Technical support: 1-877-715-2664
Web site: www.townandcountryfireplaces.net
2975 Allenby Rd., Duncan, BC V9L 6V8